

**UDC3200
Universal Digital Controller
Product Manual**

51-52-25-119

Revision 5

March 2012

Notices and Trademarks

**Copyright 2008 by Honeywell
Revision 5 March 2012**

While this information is presented in good faith and believed to be accurate, Honeywell disclaims the implied warranties of merchantability and fitness for a particular purpose and makes no express warranties except as may be stated in its written agreement with and for its customers.

In no event is Honeywell liable to anyone for any indirect, special or consequential damages. The information and specifications in this document are subject to change without notice.

Honeywell, PlantScape, Experion PKS, and **TotalPlant** are registered trademarks of Honeywell International Inc.

Other brand or product names are trademarks of their respective owners.

Honeywell Process Solutions

1860 West Rose Garden Lane
Phoenix, Arizona 85027

About This Document

Abstract

This document provides descriptions and procedures for the Installation, Configuration, Operation, and Troubleshooting of your UDC3200 Controller.

Revision Information

Document Name	Document ID	Revision Number	Publication Date
UDC3200 Universal Digital Controller Product Manual			
Input Voltage change	51-52-25-119	5	March 2012

References

The following list identifies all documents that may be sources of reference for material discussed in this publication.

Document Title	
Process Instrument Explorer manual	51-52-25-131
How to Apply Digital Instrumentation in Severe Electrical Noise Environments.	51-52-05-01
Modbus RTU Serial Communications User Manual	51-52-25-66
MODBUS Messaging on TCP/IP Implementation Guide.	51-52-25-121

Support and Contact info

United States and Canada

Contact: Honeywell Process Solution

- Global Technical Support - Phone: 001-800-423-9883
- Customer Service (HFS) - Phone: 001-800-343-0228
- Outside United States - Phone: 001-215-641-3610

Calls are answered by dispatcher between 6:00 am and 4:00 pm Mountain Standard Time.
Emergency calls outside normal working hours are received by an answering service and returned within one hour.

Email support: ask-ssc@honeywell.com
Mail: Honeywell Process Solutions
1860 West Rose Garden Lane,
Phoenix, Arizona 85027

For more contact details for Europe, Asia, North and South Americas, please see back page.

World Wide Web

Honeywell Process Solutions Support Online:
www.honeywellprocess.com/

Elsewhere









Call your nearest Honeywell office.

Training Classes

Honeywell Automation College:
<http://www.automationcollege.com>

Symbol Definitions

The following table lists those symbols used in this document to denote certain conditions.

Symbol	Definition
	This CAUTION symbol on the equipment refers the user to the Product Manual for additional information. This symbol appears next to required information in the manual.
	WARNING PERSONAL INJURY: Risk of electrical shock. This symbol warns the user of a potential shock hazard where HAZARDOUS LIVE voltages greater than 30 Vrms, 42.4 Vpeak, or 60 VDC may be accessible. Failure to comply with these instructions could result in death or serious injury.
	ATTENTION, Electrostatic Discharge (ESD) hazards. Observe precautions for handling electrostatic sensitive devices
	Protective Earth (PE) terminal. Provided for connection of the protective earth (green or green/yellow) supply system conductor.
	Functional earth terminal. Used for non-safety purposes such as noise immunity improvement. NOTE: This connection shall be bonded to protective earth at the source of supply in accordance with national local electrical code requirements.
	Earth Ground. Functional earth connection. NOTE: This connection shall be bonded to Protective earth at the source of supply in accordance with national and local electrical code requirements.
	Chassis Ground. Identifies a connection to the chassis or frame of the equipment shall be bonded to Protective Earth at the source of supply in accordance with national and local electrical code requirements.
	The Canadian Standards mark means the equipment has been tested and meets applicable standards for safety and/or performance.
	For radio equipment used in the European Union in accordance with the R&TTE Directive the CE Mark and the notified body (NB) identification number is used when the NB is involved in the conformity assessment procedure. The alert sign must be used when a restriction on use (output power limit by a country at certain frequencies) applies to the equipment and must follow the CE marking.

Contents

1	INTRODUCTION	1
1.1	Overview	1
1.2	Operator Interface	5
1.2.1	Function of Displays and Keys	6
1.3	Process Instrument Explorer Software.....	7
1.4	CE Conformity (Europe).....	8
2	INSTALLATION.....	11
2.1	Overview	11
2.2	Condensed Specifications	12
2.3	Model Number Interpretation	15
2.4	Control and Alarm Relay Contact Information.....	18
2.5	Mounting.....	19
2.6	Wiring	21
2.6.1	Electrical Considerations	21
2.7	Wiring Diagrams.....	23
3	CONFIGURATION.....	37
3.1	Overview	37
3.2	Configuration Prompt Hierarchy	38
3.3	Configuration Procedure.....	40
3.4	Tuning Set Up Group.....	41
3.5	SP Ramp Set Up Group	45
3.6	Accutune Set Up Group	49
3.7	Algorithm Set Up Group.....	51
3.8	Output Set Up Group	61
3.9	Input 1 Set Up Group.....	65
3.10	Input 2 Set Up Group	69
3.11	Control Set Up Group	72
3.12	Options Group	79
3.13	Communications Group	85
3.14	Alarms Set Up Group.....	88
3.15	Display Set Up Group	93
3.16	Configuration Record Sheet	95

4	MONITORING AND OPERATING THE CONTROLLER.....	97
4.1	Overview.....	97
4.2	Operator Interface	98
4.3	Entering a Security Code	98
4.4	Lockout Feature	99
4.5	Monitoring Your Controller.....	101
4.5.1	Annunciators	101
4.5.2	Viewing the operating parameters.....	102
4.5.3	Diagnostic Messages.....	103
4.6	Start Up Procedure for Operation	105
4.7	Control Modes	106
4.7.1	Mode Definitions	106
4.7.2	What happens when you change modes.....	107
4.8	Setpoints.....	107
4.9	Timer.....	109
4.10	Accutune III.....	110
4.10.1	Tune for Simplex Outputs	111
4.10.2	Tune for Duplex (Heat/Cool)	112
4.10.3	Using AUTOMATIC TUNE at start-up for Duplex (Heat/Cool).....	113
4.10.4	Using BLENDED TUNE at start-up for Duplex (Heat/Cool).....	114
4.10.5	Using MANUAL TUNE at start-up for Duplex (Heat/Cool).....	114
4.10.6	Error Codes.....	116
4.11	Fuzzy Overshoot Suppression	117
4.12	Using Two Sets of Tuning Constants.....	117
4.13	Alarm Setpoints	119
4.14	Three Position Step Control Algorithm.....	121
4.15	Setting a Failsafe Output Value for Restart After a Power Loss.....	122
4.16	Setting Failsafe Mode.....	123
4.17	Setpoint Rate/Ramp/Program Overview	123
4.18	Setpoint Rate	124
4.19	Setpoint Ramp	124
4.20	Setpoint Ramp/Soak Programming	126
5	INPUT CALIBRATION.....	133
5.1	Overview.....	133
5.2	Minimum and Maximum Range Values	134
5.3	Preliminary Information.....	136

5.4	Input 1 or 2 Set Up Wiring	137
5.4.1	Thermocouple Inputs Using an Ice Bath.....	137
5.4.2	Thermocouple Inputs Using a Thermocouple Source.....	138
5.4.3	RTD Inputs.....	138
5.4.4	Radiamatic, Millivolts, Volts or Thermocouple Differential Inputs	139
5.4.5	0 to 10 Volts.....	140
5.4.6	Milliamperes	140
5.5	Input 1 or 2 Calibration Procedure.....	141
5.6	Restore Input Factory Calibration.....	142
6	OUTPUT CALIBRATION.....	145
6.1	Overview.....	145
6.2	Current Output Calibration	146
6.3	Auxiliary Output Calibration	148
6.4	Position Proportional and Three Position Step Output Calibration	150
6.5	Restore Output Factory Calibration	153
7	TROUBLESHOOTING/SERVICE.....	155
7.1	Overview.....	155
7.2	Troubleshooting Aids.....	156
7.3	Power-up Tests.....	158
7.4	Status Tests	158
7.5	Background Tests.....	159
7.6	Controller Failure Symptoms.....	160
7.7	Troubleshooting Procedures	162
7.8	Restoring Factory Configuration	172
7.9	Software Upgrades.....	173
8	PARTS LIST	175
8.1	Exploded View.....	175
8.2	Removing the chassis.....	177
9	MODBUS RTU FUNCTION CODES.....	178
9.1	Overview.....	178
9.2	General Information.....	178
9.3	Function Code 20 (14h) - Read Configuration Reference Data.....	180
9.3.1	Read Configuration Examples	182
9.4	Function Code 21 (15h) - Write Configuration Reference Data.....	184
9.4.1	Write Configuration Examples	186

10	MODBUS READ, WRITE AND OVERRIDE PARAMETERS PLUS EXCEPTION CODES.....	187
10.1	Overview	187
10.2	Reading Control Data.....	188
10.3	Read Software Options Status.....	189
10.4	Miscellaneous Read Onlys	190
10.4.1	Register Addresses for Read Onlys	190
10.4.2	SetPoint Program Read Only Information.....	190
10.5	Setpoints	191
10.6	Using a Computer Setpoint (Overriding Controller Setpoint)	192
10.7	Configuration Parameters.....	194
10.7.1	Tuning	194
10.7.2	SP Ramp/Rate/Program.....	196
10.7.3	Accutune.....	199
10.7.4	Algorithm	200
10.7.5	Output Algorithms.....	203
10.7.6	Input 1.....	205
10.7.7	Input 2.....	208
10.7.8	Control.....	211
10.7.9	Options	214
10.7.10	Communications.....	217
10.7.11	Alarms	218
10.7.12	Display.....	220
10.8	Modbus RTU Exception Codes.....	221
11	ETHERNET TCP/IP	223
11.1	Overview	223
12	FURTHER INFORMATION.....	224
12.1	Modbus RTU Serial Communications	224
12.2	Modbus Messaging on TCP/IP.....	224
12.3	How to Apply Digital Instrumentation in Severe Electrical Noise Environments.....	224
13	INDEX.....	225
14	SALES AND SERVICE.....	229

Tables

Table 2-1 Condensed Specifications _____	12
Table 2-2 Control Relay Contact Information _____	18
Table 2-3 Alarm Relay Contact Information _____	18
Table 2-4 Mounting Procedure _____	20
Table 2-5 Permissible Wiring Bundling _____	22
Table 2-6 Universal Output Functionality and Restrictions _____	24
Table 2-7 Terminals for connecting a UDC to a MDI Compliant Hub or Switch _____	35
Table 2-8 Terminals for connecting a UDC directly to a PC utilizing a straight-through cable _____	35
Table 3-1 Configuration Topics _____	37
Table 3-2 Configuration Prompt Hierarchy _____	38
Table 3-3 Configuration Procedure _____	40
Table 3-4 TUNING Group Function Prompts _____	41
Table 3-5 SPRAMP Group Function Prompts _____	45
Table 3-6 ACCUTUNE Group Function Prompts _____	49
Table 3-7 ALGORITHM Group Function Prompts _____	51
Table 3-8 OUTPUT Group Function Prompts _____	61
Table 3-9 INPUT 1 Group Function Prompts _____	65
Table 3-10 INPUT 2 Group Function Prompts _____	69
Table 3-11 CONTROL Group Function Prompts _____	72
Table 3-12 OPTION Group Function Prompts _____	79
Table 3-13 Communications Group Function Prompts _____	85
Table 3-14 ALARMS Group Function Prompts _____	88
Table 3-15 DISPLAY Group Function Prompts _____	93
Table 4-1 Procedure to Enter a Security Code _____	99
Table 4-2 Annunciators _____	101
Table 4-3 Lower Display Key Parameter Prompts _____	102
Table 4-4 Diagnostic Messages _____	103
Table 4-5 Procedure for Starting Up the Controller _____	105
Table 4-6 Control Mode Definitions _____	106
Table 4-7 Changing Control Modes _____	107
Table 4-8 Procedure for Changing the Local Setpoints _____	108
Table 4-9 Procedure for Switching Between Setpoints _____	108
Table 4-10 Procedure for Starting “TUNE” _____	111
Table 4-11 Procedure for Using AUTOMATIC TUNE at Start-up for Duplex Control _____	113
Table 4-12 Procedure for Using BLENDED TUNE at Start-up for Duplex Control _____	114
Table 4-13 Procedure for Using MANUAL TUNE for Heat side of Duplex Control _____	114
Table 4-14 Procedure for Using MANUAL TUNE for Cool side of Duplex Control _____	115
Table 4-15 Procedure for Accessing Accutune Error Codes _____	116
Table 4-16 Accutune Error Codes _____	116
Table 4-17 Set Up Procedure _____	118
Table 4-18 Procedure for Switching PID SETS from the Keyboard _____	119
Table 4-19 Procedure for Displaying Alarm Setpoints _____	120
Table 4-20 Procedure for Displaying 3Pstep Motor Position _____	121
Table 4-21 Procedure for Setting a Failsafe Value _____	122
Table 4-22 Procedure for Setting a Failsafe Mode _____	123
Table 4-23 Running A Setpoint Ramp _____	125
Table 4-24 Program Contents _____	127
Table 4-25 Run/Monitor Functions _____	131

Table 5-1 Voltage, Milliamp and Resistance Equivalents for Input Range Values _____	134
Table 5-2 Equipment Needed _____	136
Table 5-3 Set Up Wiring Procedure for Thermocouple Inputs Using an Ice Bath _____	137
Table 5-4 Set Up Wiring Procedure for Thermocouple Inputs using Thermocouple Source _____	138
Table 5-5 Set Up Wiring Procedure for RTD Inputs _____	138
Table 5-6 Set Up Wiring Procedure for Radiamatic, Millivolts, Volts or Thermocouple Differential Inputs (Except 0-10 Volts) _____	139
Table 5-7 Set Up Wiring Procedure for 0 to 10 Volts _____	140
Table 5-8 Set Up Wiring Procedure for Milliampere Inputs _____	140
Table 5-9 Input 1 or 2 Calibration Procedure _____	141
Table 5-10 Restore Factory Calibration _____	143
Table 6-1 Set Up Wiring Procedure for Current Output _____	146
Table 6-2 Current Output Calibration Procedure _____	147
Table 6-3 Set Up Wiring Procedure for Auxiliary Output _____	148
Table 6-4 Auxiliary Output Calibration Procedure _____	149
Table 6-5 Position Proportional and Three Position Step Output Calibration Procedure _____	150
Table 6-6 Restore Factory Calibration _____	153
Table 7-1 Procedure for Identifying the Software Version _____	157
Table 7-2 Procedure for Displaying the Status Test Results _____	158
Table 7-3 Background Tests _____	159
Table 7-4 Controller Failure Symptoms _____	161
Table 7-5 Troubleshooting Power Failure Symptoms _____	163
Table 7-6 Troubleshooting Current Output Failure _____	163
Table 7-7 Troubleshooting Position Proportional Output Failure _____	164
Table 7-8 Troubleshooting Time Proportional Output Failure _____	165
Table 7-9 Troubleshooting Current/Time or Time/Current Proportional Output Failure _____	166
Table 7-10 Troubleshooting Alarm Relay Output Failure _____	167
Table 7-11 Troubleshooting a Keyboard Failure _____	168
Table 7-12 Troubleshooting a RS-485 Communications Failure _____	169
Table 7-13 Troubleshooting an Ethernet Communications Failure _____	170
Table 7-14 Troubleshooting Auxiliary Output Failure _____	171
Table 7-15 Restoring Factory Configuration _____	172
Table 7-16 Software Upgrades _____	173
Table 8-1 Parts Identification _____	176
Table 8-2 Parts Not Shown _____	176
Table 8-3 Software Upgrades (see Section 7.9) _____	176
Table 9-1 Integer Parameter Type _____	179
Table 9-2 Floating Point Parameter Type _____	179
Table 9-3 Register Address Format for Function Code 20 _____	181
Table 9-4 Register Address Format for Function Code 21 _____	185
Table 10-1 Control Data Parameters _____	189
Table 10-2 Option Status _____	189
Table 10-3 Miscellaneous Read Onlys _____	190
Table 10-4 SetPoint Program Read Only Information _____	190
Table 10-5 Setpoint Code Selections _____	191
Table 10-6 Setpoint Associated Parameters _____	192
Table 10-7 Computer Setpoint Selection _____	192
Table 10-8 Computer Setpoint Associated Parameters _____	193
Table 10-9 Set-up Group – Tuning _____	194
Table 10-10 Set-up Group – Setpoint Ramp/Rate _____	196

Table 10-11	Set-up Group – Adaptive Tune	199
Table 10-12	Set-up Group – Algorithm	200
Table 10-13	Set-up Group – Output	203
Table 10-14	Set-up Group – Input 1	205
Table 10-15	Set-up Group – Input 2	208
Table 10-16	Set-up Group – Control	211
Table 10-17	Set-up Group – Options	214
Table 10-18	Set-up Group – Communications	217
Table 10-19	Set-up Group – Alarms	218
Table 10-20	Set-up Group – Display	220
Table 10-21	Modbus RTU Data Layer Status Exception Codes	222

Figures

Figure 1-1 UDC3200 Operator Interface _____	5
Figure 1-2 Screen capture of Process Instrument Explorer running on a Pocket PC _____	7
Figure 1-3 Depiction of infrared communications _____	8
Figure 2-1 Model Number Interpretation _____	15
Figure 2-2 Mounting Dimensions (not to scale) _____	19
Figure 2-3 Mounting Methods _____	20
Figure 2-4 Composite Wiring Diagram _____	25
Figure 2-5 Mains Power Supply _____	26
Figure 2-6 Input 1 Connections _____	27
Figure 2-7 Input 2 Connections _____	28
Figure 2-8 Electromechanical Relay Output _____	29
Figure 2-9 Solid State Relay Output _____	30
Figure 2-10 Open Collector Output _____	31
Figure 2-11 Dual Electromechanical Relay Option Output _____	32
Figure 2-12 Current Output _____	32
Figure 2-13 Position Proportional or Three Position Step Control Connections w/o Dual Relay Option _____	33
Figure 2-14 Position Proportional or Three Position Step Control Connections with Dual Relay Option _____	33
Figure 2-15 RS-422/485 Communications Option Connections _____	34
Figure 2-16 Ethernet Communications Option Connections _____	34
Figure 2-17 Auxiliary Output and Digital Inputs Option Connections _____	35
Figure 2-18 Transmitter Power for 4-20 mA — 2 wire Transmitter Using Open Collector Alarm 2 Output _____	36
Figure 2-19 Transmitter Power for 4-20 mA — 2 Wire Transmitter Using Auxiliary Output _____	36
Figure 3-1 Mass Flow Example _____	59
Figure 4-1 Operator Interface _____	98
Figure 4-2 Functional Overview Block Diagram of the UDC3200 Controller _____	104
Figure 4-3 Ramp/Soak Profile Example _____	129
Figure 4-4 Program Record Sheet _____	130
Figure 5-1 Input 1 and Input 2 Wiring Terminals _____	136
Figure 5-2 Wiring Connections for Thermocouple Inputs Using an Ice Bath _____	137
Figure 5-3 Wiring Connections for Thermocouple Inputs Using Thermocouple Source _____	138
Figure 5-4 Wiring Connections for RTD (Resistance Thermometer Device) _____	138
Figure 5-5 Wiring Connections for Radiamatic, Thermocouple Differential, Millivolts or Volts (Except 0 to 10 Volts) _____	139
Figure 5-6 Wiring Connections for 0 to 10 Volts _____	140
Figure 5-7 Wiring Connections for 0 to 20 mA or 4 to 20 mA Inputs _____	140
Figure 6-1 Wiring Connections for Calibrating Current Proportional Output _____	146
Figure 6-2 Wiring Connections for Calibrating Auxiliary Output _____	148
Figure 8-1 UDC3200 Exploded View _____	175
Figure 10-1 Software Option Status Information _____	189

1 Introduction

1.1 Overview

Function

The UDC3200 is a microprocessor-based stand-alone controller. It combines a high degree of functionality and operating simplicity in a 1/4 DIN size controller. This instrument is an ideal controller for regulating temperature and other process variables in numerous heating and cooling applications, as well as in metal working, food, pharmaceuticals, semiconductor, testing and environmental work.

The UDC3200 monitors and controls temperatures and other variables in applications such as environmental chambers, plastic processing machines, furnaces and ovens, and packaging machinery.

Features

- 2 Universal Analog Inputs
- 0.20% Accuracy
- Fast scanning rate (166ms)
- Up to 5 Analog and Digital Output Types
- 2 Digital Inputs
- Math Functions
- Ethernet and Modbus communication
- Infrared PC & Pocket PC configuration
- NEMA4X and IP66 front face protection
- Multilanguage prompts
- 1/4 DIN Size
- Jumper free configuration
- Easily Field Upgradable

Easy to read displays

Bright, dual displays with multi-language prompts (in English, French, German, Spanish, or Italian) make the operator interface easy to read, understand, and operate. Simple keystrokes let you set operating parameters that meet your process control needs.

Analog Inputs

The UDC3200 has two analog inputs with a typical accuracy of $\pm 0.20\%$ of full-scale input and a typical resolution of 16 bits. Both analog inputs are sampled six times per second (every 166 ms).

The first, or Process Variable input, can be one of the various thermocouple, RTD, Radiamatic or linear actuators. Linear actuators have thermocouple, RTD, and Radiamatic transmitter characterization capability as a standard feature. Linear actuators also have square root capability.

The optional second input is isolated and accepts the same actuators as input one, or it provides the Slidewire input for Position Proportional control.

All actuators and characterizations are keyboard configurable. Cold junction compensation is provided for thermocouple type inputs. Upscale, downscale or failsafe sensor break protection is keyboard configurable. A configurable digital filter of 0 to 120 seconds provides input signal damping.

Thermocouple Health - In addition to the standard configurable upscale, downscale or failsafe output burnout selections, the condition of the thermocouple can be monitored to determine if it is good, failing or in danger of imminent failure.

Math Functions

Algorithm—A pre-configured algorithm is available for easy implementation. This includes the capability of using a Ratio and Bias with any input. You can select from the following menu:

Feedforward Summer—Uses either input, followed by a Ratio/Bias calculation, summed directly with the computed PID output value to provide a resultant output to the final control element (standard feature).

Weighted Average —Computes the weighted average of a PV or SP for the control algorithm from two inputs (standard feature).

Feedforward Multiplier—Uses any input, multiplied by the calculated PID output to provide a resultant output which is sent to the final control element (standard feature).

Summer/Subtractor—Will add or subtract inputs with the result used as the derived PV.

Multiplier/Divider—Uses the analog inputs to calculate a derived PV. Available with or without Square Root.

Input High/Low Select—Specifies the PV input as the higher or lower of the two inputs.

Digital Inputs

Two isolated digital inputs are provided for remote dry contact closure to select one of 25 actions. Also, the digital inputs can allow one of six selections to be combined with one of the above selections.

Outputs

Output Types - The UDC3200 may have up to five of the following outputs:

- Current Outputs (4-20 or 0-20 ma)
- Electromechanical Relays (5 amps)
- Solid State Relays (1 amp)
- Dual Electromechanical Relays (2 amps)
- Open Collector Outputs

Alarms

One or two electromechanical alarm relays are available to activate external equipment when preset alarm setpoints are reached. Each of the two alarms can be set to monitor two independent setpoints. Each alarm setpoint can be either high or low alarm. The alarm type can be selected to be either of the inputs, the Process Variable, Deviation, Output, Shed from communications, PV rate of change, or to alarm on manual mode activation or a Current Output Open failure. It can also be used as an On or Off event at the beginning or end of a Ramp/Soak segment. The alarm hysteresis is configurable from 0 to 100% of range.

- Alarms can be configured as latching or non-latching.
- Alarm blocking is also available which allows start-up without alarm energized until after it first reaches the operating region.
- PV rate of change alarm.
- Loop break alarm.
- Timer output reset.
- Diagnostic Alarm

Communications

A communications link is provided between the UDC3200 and a host computer or PLC via the RS422/485 Modbus® RTU or Ethernet TCP/IP communications option. An infrared communication link is also available allowing a non-intrusive configuration of the instrument.

Miscellaneous Features

Auxiliary Output*(optional) - Either or both of the two current outputs can function as an Auxiliary Output which can be scaled from 4-20 ma for 0 to 100% for any range. It can be configured to represent Input 1, Input 2, PV, active Setpoint, Local SP1, Deviation, or the Control Output.

Transmitter Power - This output provides up to 30 volts dc to power a 2-wire transmitter (it requires the use of alarm 2 open collector output selection or the second current output).

Three Local and one Remote Setpoints - Can be configured to provide three Local and one Remote Setpoints, which are selectable either via the keyboard or by Digital Input.

Universal Switching Power - Operates on any line voltage from 90 to 250 Vac 50/60 Hz without jumpers. 24 Vac/dc instrument power is available as an option.

Timer - This standard feature provides a configurable time period of 0 to 99 hours, 59 minutes or units of minutes and seconds. It can be started via the keyboard, alarm 2, or by a digital input. The timer output is Alarm 1, which energizes at the end of the Timer Period. Alarm 1 can be automatically reset. The Timer Period can be changed between each batch. Status is shown on the lower display.

Moisture Protection - The NEMA4X and IP66 rated front face permits use in applications where it may be subjected to moisture, dust, or hose-down conditions.

Setpoint Ramp/Soak Programming (Optional) - Enables you to program and store six Ramp and six Soak segments for setpoint programming. Run or Hold of program is keyboard or remote digital switch selectable.

Setpoint Rate - Lets you define a ramp rate to be applied to any local setpoint change. A separate upscale or downscale rate is configurable. A single setpoint ramp is also available as an alternative.

CE Mark - Conformity with 73/23/EEC, Low Voltage Directive and 89/336/EEC, the EMC Directive as a standard feature.

Approval Body Options - CSA certification is available as an option. UL listing is standard.

Two Sets of Tuning Constants - Two sets of PID parameters can be configured for each loop and automatically or keyboard selected.

Data Security - Five levels of keyboard security protect tuning, configuration, and calibration data, accessed by a configurable 4-digit code. Nonvolatile EEPROM memory assures data integrity during loss of power.

Diagnostic/Failsafe Outputs - Continuous diagnostic routines detect failure modes, trigger a failsafe output value and identify the failure to minimize troubleshooting time.

High Noise Immunity - The controller is designed to provide reliable, error-free performance in industrial environments that often affect highly noise-sensitive digital equipment.

Accutune III™ - This standard feature provides a truly plug and play tuning algorithm, which will, at the touch of a button or through a digital input, accurately identify and tune any process including those with deadtime and integrating processes. This speeds up and simplifies start-up plus allows retuning at any setpoint. The algorithm used is an improved version of the Accutune II™ algorithm found on earlier controllers. Two possibilities are now offered when tuning your process: Fast Tune and Slow Tune.

Fast Tune will tune the process in such a way that the temp is reached faster, a slight overshoot will be allowed.

Slowtune will minimize overshoot, but it will take more time for the process temperature to reach the target setpoint.

Heat/Cool (Duplex Tune) will automatically tune both the heating and cooling sides of the process.

Fuzzy Logic - This standard feature uses fuzzy logic to suppress process variable overshoot due to SP changes or externally induced process disturbances. It operates independently from Accutune III™ tuning. It does not change the PID constants, but temporarily modifies the internal controller response to suppress overshoot. This allows more aggressive tuning to co-exist with smooth PV response. It can be enabled or disabled depending on the application or the control criteria.

1.2 Operator Interface













Figure 1-1 UDC3200 Operator Interface

1.2.1 Function of Displays and Keys

Table 1-1 Function of Displays and Keys

Display Indicators	
<p>3200 Upper display with 4 larger digits shows Process Variable value (normal operation) and special annunciator features. During Configuration, the upper display provides guidance for the operator through prompts (7 – characters)</p> <p>SP 3200 During normal operation, the lower display shows key-selected operating parameters such as Output, Setpoints, Inputs, Deviation, active Tuning Parameter Set, Timer Status, or minutes remaining in a setpoint ramp (4 digits). During configuration, the lower display provides guidance for the operator through prompts (8-characters).</p> <p>ALM Indicates Alarm 1 and/or Alarm 2 conditions exist.</p> <p>DI Indicates Digital Input 1 and/or 2 on.</p>	<p>OUT Indicates Control Relay 1 and/or 2 on.</p> <p>F Or C Indicates either degrees Fahrenheit or Centigrade.</p> <p>MAN Or A Indicates either Manual or Auto mode.</p> <p>SP Indicates Local Setpoint #1. Also, a bar is lighted when the setpoint being used is shown on the lower display.</p>

Keys and Functions

<p> Selects functions within each configuration group.</p> <p> Scrolls through the configuration groups.</p> <p> Returns Controller to normal display from Set Up mode. Toggles various operating parameters for display.</p> <p> Increases setpoint or output value. Increases the configuration values or changes functions in Configuration mode groups.</p> <p> Infrared transceiver</p>	<p> Selects Manual or Auto mode.</p> <p> Hold key down to cycle through configured setpoints.</p> <p> Enables Run/Hold of the SP Ramp or Program plus Timer start.</p> <p> Decreases setpoint or output value. Decreases the configuration values or changes functions in Configuration mode groups.</p> <p> NEMA4X and IP66 screw attachment (each corner)</p>
---	--

1.3 Process Instrument Explorer Software

Overview

Process Instrument Explorer lets you configure your instrument on a desktop/laptop or Pocket PC. For details see Process Instrument Explorer manual #51-52-25-131.

Features

- Create configurations with intuitive software program running on a Pocket PC, a Desktop or a laptop computer.
- Create/edit configurations live, just connect software to the controller via a communications port.
- Create/edit configurations offline and download to controller later via a communications port.
- Communication types available on every UDC3200:
 - Infrared (standard)
 - RS 485(optional)
 - Ethernet (optional)
- Same port types on UDC2500 and UDC3500 allow interconnectivity.
- This software is available in English, Spanish, Italian, German and French.

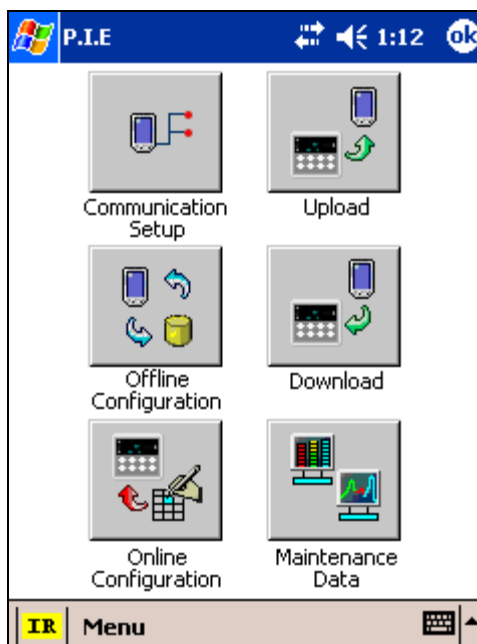

Figure 1-2 Screen capture of Process Instrument Explorer running on a Pocket PC

Infrared communications

The infrared connection provides a non-intrusive wireless connection with the instrument and maintains NEMA4X AND IP66 integrity.

No need to get access to the back of the controller to communicate with the instrument, no need to take your screw driver to wire the communication cable, no wiring mistake possible. You can now duplicate an instrument's configuration, upload or download a new configuration in a matter of seconds, just by pointing your Pocket PC in the direction of the instrument.

It takes just a few seconds to upload a configuration from an instrument. You can then save the configuration file onto your PC or pocket PC for review, modification or archiving. Furthermore, this software also gives you important maintenance information on the controller: instantly, get information on the current operating parameters, digital inputs and alarm status, identify internal or analog input problems.

Question: What if I have several controllers on the same panel? How can I be sure I am communicating with the correct one?

Answer: The infrared port of the controller is normally "off". You activate the infrared port by pressing any controller's key. You can now communicate. After 4 minutes, the port will be shut down again. Each controller may also be assigned a different communications address.



Figure 1-3 Depiction of infrared communications

1.4 CE Conformity (Europe)

This product is in conformity with the protection requirements of the following European Council Directives: **73/23/EEC**, the Low Voltage Directive, and **89/336/EEC**, the EMC Directive. Conformity of this product with any other "CE Mark" Directive(s) shall not be assumed.

Product Classification: Class I: Permanently connected, panel-mounted Industrial Control Equipment with protective earthing (grounding) (EN61010-1).

Enclosure Rating: This controller must be panel-mounted with the rear terminals enclosed within the panel. The front panel of the controller is rated at NEMA4X and IP66 when properly installed.

Installation Category (Overvoltage Category): Category II (EN61010-1)

Pollution Degree: Pollution Degree 2: Normally non-conductive pollution with occasional conductivity caused by condensation. (Ref. IEC 664-1)

EMC Classification: Group 1, Class A, ISM Equipment (EN61326, emissions), Industrial Equipment (EN61326, immunity)

Method of EMC Assessment: Technical File (TF)

Declaration of Conformity: 51453663

Deviation from the installation conditions specified in this manual, and the special conditions for CE conformity in Subsection 2.1, may invalidate this product's conformity with the Low Voltage and **EMC** Directives.

ATTENTION

The emission limits of EN61326 are designed to provide reasonable protection against harmful interference when this equipment is operated in an industrial environment. Operation of this equipment in a residential area may cause harmful interference. This equipment generates, uses, and can radiate radio frequency energy and may cause interference to radio and television reception when the equipment is used closer than 30 meters (98 feet) to the antenna(e). In special cases, when highly susceptible apparatus is used in close proximity, the user may have to employ additional mitigating measures to further reduce the electromagnetic emissions of this equipment.

WARNING

If this equipment is used in a manner not specified by the manufacturer, the protection provided by the equipment may be impaired.

2 Installation

2.1 Overview

Introduction

Installation of the UDC3200 consists of mounting and wiring the controller according to the instructions given in this section. Read the pre-installation information, check the model number interpretation (Subsection 2.3), and become familiar with your model selections, then proceed with installation.

What's in this section?

The following topics are covered in this section.

TOPIC	See Page
2.1 Overview	11
2.2 Condensed Specifications	12
2.3 Model Number Interpretation	15
2.4 Control and Alarm Relay Contact Information	18
2.5 Mounting	19
2.6 Wiring	21
2.7 Wiring Diagrams	23
Composite Wiring Diagram	25
AC Line Voltage	26
Input 1 Connections	27
Input 2 Connections	28
Relay Output	
Electromechanical	29
Solid State	30
Open Collector	31
Dual Electromechanical Relay	32
Current Output Connections	32
Three Position Step Control Connections w/o Dual Relay	33
Three Position Step Control Connections with Dual Relay	33
RS-422/485 Communications Option	34
Ethernet Communications Option	34
Auxiliary Output and Digital Inputs Option	35
Transmitter Power using Open Collector Output	36
Transmitter Power using Auxiliary Output	36

Pre-installation Information

If the controller has not been removed from its shipping carton, inspect the carton for damage then remove the controller.

- Inspect the unit for any obvious shipping damage and report any damage due to transit to the carrier.
- Make sure a bag containing mounting hardware is included in the carton with the controller.
- Check that the model number shown on the inside of the case agrees with what you have ordered.

2.2 Condensed Specifications

Honeywell recommends that you review and adhere to the operating limits listed in Table 2-1 when you install your controller.

Table 2-1 Condensed Specifications

Specifications	
Analog Inputs	<p><i>Accuracy:</i> $\pm 0.20\%$ of full scale typical (± 1 digit for display) Can be field calibrated to $\pm 0.05\%$ of full scale typical 16-bit resolution typical</p> <p><i>Sampling Rate:</i> Both inputs are sampled six times per second</p> <p><i>Temperature Stability:</i> $\pm 0.01\%$ of Full Scale span / °C change—typical</p> <p><i>Input Impedance:</i> 4-20 Milliampere Input: 250 ohms 0-10 Volt Input: 200K ohms All Others: 10 megohms</p> <p><i>Maximum Lead Wire Resistance:</i> Thermocouples: 50 ohms/leg 100 ohm, 200 ohm and 500 ohm RTD: 100 ohms/leg 100 ohm Low RTD: 10 ohms/leg</p> <p><i>Slidewire Inputs for Position Proportional Control:</i> 100 ohm minimum to 1000 ohms maximum</p>
Analog Input Signal Failure Operation	<p><i>Burnout Selections:</i> Upscale, Downscale, Failsafe or None <i>Thermocouple Health:</i> Good, Failing, Failure Imminent or Failed <i>Failsafe Output Level:</i> Configurable 0-100% of Output range</p>
Stray Rejection	<p>Common Mode <i>AC (50 or 60 Hz):</i> 120 dB (with maximum source impedance of 100 ohms) or ± 1 LSB (least significant bit) whichever is greater with line voltage applied. <i>DC:</i> 120 dB (with maximum source impedance of 100 ohms) or a ± 1 LSB whichever is greater with 120 Vdc applied. <i>DC (to 1 KHz):</i> 80 dB (with maximum source of impedance of 100 ohms) or ± 1 LSB whichever is greater with 50 Vac applied.</p> <p>Normal Mode <i>AC (50 or 60 Hz):</i> 60 dB (with 100 % span peak-to-peak maximum)</p>
Digital Inputs (Two) (Optional)	<p>+30 Vdc source for external dry contacts or isolated solid state contacts. Digital Inputs are isolated from line power, earth ground, analog inputs and all outputs except for the Second Current Output.</p> <p>The second Digital Input is mutually exclusive with the Second Current Output.</p>

Specifications	
Controller Output Types	<p>Electromechanical Relays (One or Two) SPDT contacts. Both Normally Open and Normally Closed contacts are brought out to the rear terminals. Internally socketed. <i>Resistive Load:</i> 5 amps @ 120 Vac or 240 Vac or 30 Vdc <i>Inductive Load ($\cos\phi = 0.4$):</i> 3 amps @ 130 Vac or 250 Vac <i>Inductive Load ($L/R = 7$ msec):</i> 3.5 amps @ 30 Vdc <i>Motor:</i> 1/6 H.P.</p> <p>Dual Electromechanical Relays Two SPST relays. One Normally Closed contact for each relay is brought out to the rear terminals. This option takes the place of one of the above electromechanical relays, and is especially useful for Time Duplex or Three Position Step Control or Position Proportional Control applications. Instruments with this option can have a total of 4 relays plus one current output. Internally socketed <i>Resistive Load:</i> 2 amps @ 120 Vac, 240 Vac or 30 Vdc <i>Inductive Load ($\cos\phi = 0.4$):</i> 1 amp @ 130 Vac or 250 Vac <i>Inductive Load ($L/R = 7$ msec):</i> 1 amp @ 30 Vdc</p> <p>Solid State Relays (One or Two) Zero-crossing type SPST solid state contacts consisting of a triac N.O. output. Internally socketed. <i>Resistive Load:</i> 1.0 amp @ 25°C and 120 or 240 Vac, 0.5 amp @ 55°C and 120 or 240 Vac <i>Inductive Load:</i> 50 VA @ 120 Vac or 240 Vac <i>Minimum Load:</i> 20 milliamps</p> <p>Open Collector Outputs (One or Two) Socketed assembly replacing a relay. Opto-isolated from all other circuits except current output and not from each other. Internally powered @ 30 Vdc. Note: Applying an external power supply to this output will damage the instrument. <i>Maximum Sink Current:</i> 20 mA <i>Short-circuit current limit:</i> 100 mA</p> <p>Current Outputs (One or Two) These outputs provide a 21 mA dc maximum into a negative or positive grounded load or into a non-grounded load. Current outputs are isolated from each other, line power, earth ground and all inputs. Outputs can be easily configured via the keyboard for either direct or reverse action and for either 0 to 20 mA or 4 to 20 mA without field calibration. Both current outputs can be used in an Auxiliary Output mode. This Auxiliary Output can be configured to represent Input, PV, Setpoint, Deviation, or Control output. The range of an Auxiliary Output can be scaled per the range of the selected variable and can be set anywhere between 0 to 21 mA. The Second Current Output is mutually exclusive with the second Digital Input. <i>Resolution:</i> 14 bits over 0 to 21 mA <i>Accuracy:</i> 0.05% of full scale <i>Temperature Stability:</i> 0.01% F.S./°C <i>Load Resistance:</i> 0 to 1000 ohms</p>
Alarm Outputs (Optional)	<p>One SPDT Electromechanical relay. A second alarm is available if the second control relay is not used for control purposes or when the Dual Relay Option is used. Up to four setpoints are independently set as high or low alarm, two for each relay. Setpoint can be on any Input, Process Variable, Deviation, Manual Mode, Failsafe, PV Rate, RSP Mode, Communication Shed, or Output. A single adjustable hysteresis of 0.0 to 100.0% is provided. The alarm can also be set as an ON or OFF event at the beginning of a Setpoint ramp/soak segment. <i>Alarm Relay Contacts Rating:</i> Resistive Load: 5 amps at 120 Vac or 240 Vac or 30 Vdc</p>
Isolation (Functional)	<p><i>AC Power:</i> Electrically isolated from all other inputs and outputs and earth ground to withstand a HIPOT potential of 1900 Vdc for 2 seconds per Annex K of EN61010-1. <i>Analog Inputs and Outputs:</i> Are isolated from each other and all other circuits at 850 Vdc for 2 seconds. <i>Digital Inputs and Digital Outputs:</i> Electrically isolated from all other circuits to withstand a HIPOT potential of 850 Vdc for 2 seconds per Annex K of EN61010-1.</p>

Specifications	
	<i>Relay Contacts:</i> With a working voltage of 115/230 Vac, these are electrically isolated from all other circuits to withstand a HIPOT potential of 345 Vdc for 2 seconds per Annex K of EN61010-1
RS422/485 Modbus RTU Communications Interface (Optional)	<i>Baud Rate:</i> 4800, 9600, 19,200 or 38,400 baud selectable <i>Data Format:</i> Floating point or integer <i>Length of Link:</i> 2000 ft (600 m) max. with Belden 9271 Twinax Cable and 120 ohm termination resistors 4000 ft. (1200 m) max. with Belden 8227 Twinax Cable and 100 ohm termination resistors <i>Link Characteristics:</i> Two-wire, multi-drop Modbus RTU protocol, 15 drops maximum or up to 31 drops for shorter link length.
Ethernet TCP/IP Communications Interface (Optional)	<i>Type:</i> 10Base-T <i>Length of Link:</i> 330 ft. (100 m) maximum <i>Link Characteristics:</i> Four-wire, single drop, five hops maximum <i>IP Address:</i> IP Address is 10.0.0.2 as shipped from the Factory <i>Recommended network configuration:</i> Use Switch rather than Hub in order to maximize UDC Ethernet performance
Infrared Communications (Standard)	<i>Type:</i> Serial Infrared (SIR) <i>Length of Link:</i> 3 ft. (1 m) maximum for IrDA 1.0 compliant devices <i>Baud Rate:</i> 19,200 or 38,400 baud selectable
Power Consumption	18 VA maximum (90 to 250 Vac) 12 VA maximum (24 Vac/dc)
Power Inrush Current	10A maximum for 4 ms (under operating conditions), reducing to a maximum of 225 mA (90 to 250 Vac operation) or 750 mA (24 Vac/dc operation) after one second. CAUTION When applying power to more than one instrument, make sure that sufficient power is supplied. Otherwise, the instruments may not start up normally due to voltage drop from the inrush current.
Weight	3 lbs. (1.3 kg)

Environmental and Operating Conditions				
Parameter	Reference	Rated	Operative Limits	Transportation and Storage
Ambient Temperature	25 ± 3 °C 77 ± 5 °F	15 to 55 °C 58 to 131 °F	0 to 55 °C 32 to 131 °F	-40 to 66 °C -40 to 151 °F
Relative Humidity	10 to 55*	10 to 90*	5 to 90*	5 to 95*
Vibration Frequency (Hz) Acceleration (g)	0 0	0 to 70 0.4	0 to 200 0.6	0 to 200 0.5
Mechanical Shock Acceleration (g) Duration (ms))	0 0	1 30	5 30	20 30
Line Voltage (Vdc)	+24 ± 1	22 to 27	20 to 30	--
Line Voltage (Vac) 90 to 240 Vac 24 Vac	120 ± 1 240 ± 2 24 ± 1	90 to 240 20 to 27	90 to 250 20 to 27	-- -- --
Frequency (Hz) (For Vac)	50 ± 0.2 60 ± 0.2	49 to 51 59 to 61	48 to 52 58 to 62	-- --

* The maximum moisture rating only applies up to 40 °C (104 °F). For higher temperatures, the RH specification is derated to maintain constant moisture content.

2.3 Model Number Interpretation

Introduction

Write your controller's model number in the spaces provided below and circle the corresponding items in each table. This information will also be useful when you wire your controller.

Figure 2-1 Model Number Interpretation



51-51-16U-80
Issue 13
Page 1 of 3

UDC3200 Universal Digital Controller

Model Selection Guide

New! Easy To Use UDC3200 1/4 DIN Single Loop Controller

The UDC3200 Controller packs new powerful features while retaining all the simplicity and flexibility of the industry standard UDC3300 Controller. Many new optional features include:

- Enhanced Display
- Built-in infrared communications port for configuring with a Pocket PC or Laptop
- PC Based Configuration Tools
- Ethernet Communications
- Two Analog Inputs
- Accutune III, Fast/Slow, Heat/Cool
- Thermocouple Health Monitoring

Instructions

- Select the desired key number. The arrow to the right marks the selection available.
- Make the desired selections from Tables I through VI using the column below the proper arrow. A dot (•) denotes availability.

Key Number I II III IV V VI

 -
 -
 -
 -
 -
 -

KEY NUMBER - UDC3200 Single Loop Controller

Description	Selection	Availability	
Digital Controller for use with 90 to 250Vac Power	DC3200	↓	↓
Digital Controller for use with 24Vac/dc Power	DC3201	↓	↓

TABLE I - Specify Control Output and/or Alarms

Output #1	Description	C	E	A	T	R
Output #1	Current Output (4 to 20ma, 0 to 20 ma)	•	•	•	•	•
	Electro Mechanical Relay (5 Amp Form C)	•	•	•	•	•
	Solid State Relay (1 Amp)	•	•	•	•	•
	Open Collector transistor output	•	•	•	•	•
	Dual 2 Amp Relays (Both are Form A) (Heat/Cool Applications)	•	•	•	•	•
Output #2 and Alarm #1 or Alarms 1 and 2	No Additional Outputs or Alarms	_0	•	•	•	•
	One Alarm Relay Only	_B	•	•	•	•
	E-M Relay (5 Amp Form C) Plus Alarm 1 (5 Amp Form C Relay)	_E	•	•	•	•
	Solid State Relay (1 Amp) Plus Alarm 1 (5 Amp Form C Relay)	_A	•	•	•	•
	Open Collector Plus Alarm 1 (5 Amp Form C Relay)	_T	•	•	•	•

TABLE II - Communications and Software Selections

Communications	Description	0	1	2	3
Communications	None	0	•	•	•
	Auxiliary Output/Digital Inputs (1 Aux and 1 DI or 2 DI)	1	•	•	•
	RS-485 Modbus Plus Auxiliary Output/Digital Inputs	2	•	•	•
	10 Base-T Ethernet (Modbus RTU) Plus Auxiliary Output/Digital Inputs	3	•	•	•
Software Selections	Standard Functions, Includes Accutune	_0	•	•	•
	Math Option	_A	•	•	•
	Set Point Programming (1 Program, 12 Segments)	_B	•	•	•
	Set Point Programming Plus Math	_C	•	•	•
Reserved	No Selection	__0	•	•	•
Infrared interface	Infrared Interface Included (Can be used with a Pocket PC)	__R	•	•	•

TABLE III - Input 1 can be changed in the field using external resistors

Input 1	TC, RTD, mV, 0-5V, 1-5V TC, RTD, mV, 0-5V, 1-5V, 0-20mA, 4-20mA TC, RTD, mV, 0-5V, 1-5V, 0-20mA, 4-20mA, 0-10V
Input 2	None TC, RTD, mV, 0-5V, 1-5V, 0-20mA, 4-20mA TC, RTD, mV, 0-5V, 1-5V, 0-20mA, 4-20mA, 0-10V Slidewire Input for Position Proportional (Requires 2 Relay Outputs) Carbon, Oxygen or Dewpoint (Provides 2 Inputs)

Selection	Availability	
	DC 3200	3201
1 __	•	•
2 __	•	•
3 __	•	•
_ 00	•	•
_ 10	•	•
_ 20	•	•
_ 40	a	a
_ 60	b	b

TABLE IV - Options

Approvals	CE (Standard) CE, UL and CSA
Tags	None Stainless Steel Customer ID Tag - 3 lines w/22 characters/line
Future Options	None
	None
	None

0 _ _ _ _	•	•
1 _ _ _ _	•	•
_ 0 _ _ _	•	•
_ T _ _ _	•	•
_ _ 0 _ _	•	•
_ _ _ 0 _	•	•
_ _ _ _ 0	•	•

TABLE V - Product Manuals

Manuals	Product Information on CD - All Languages English Manual French Manual German Manual Italian Manual Spanish Manual
Certificate	None Certificate of Conformance (F3391)

0 _	•	•
E _	•	•
F _		
G _		
I _		
S _		
_ 0	•	•
_ C	•	•

TABLE VI

No Selection	None
--------------	------

0	•	•
---	---	---

ORDERING INSTRUCTIONS: These are provide as guidance for ordering such as those listed

1. Part numbers are provided to facilitate Distributor Stock.
2. Orders may be placed either by model selection or by part number.
3. Part numbers are shown within the model selection tables to assist with compatibility information.
4. Orders placed by model selection are systematically protected against incompatibility.
5. Compatibility assessment is the responsibility of the purchaser for orders placed by part number.
6. Items labeled as N/A are not available via the stocking program and must be ordered by model selection.

RESTRICTIONS

Restriction Letters	Available Only With		Not Available With	
	Table	Selection	Table	Selection
a	I	EE		
	I	AA		
	I	R _		
b	III	1 __		



51-51-16U-80

Issue 13

Page 3 of 3

UDC3200 Universal Digital Controller

Supplemental Accessories & Kits

Description	Part Number	
Bezel Assembly and Bezel Gasket	51453143-502	
Display/Keyboard (with IR)	51452845-501	
Power/Output PWA with 2 E-M Relays (90-264 Vac Operation)	51452822-502	
Power/Output PWA with 2 E-M Relays (24 Vac/dc Operation)	51452822-503	
Optional Analog Input PWA	51452825-501	
Auxiliary Output/Digital Input/RS-422/485 Communications PWA	51452810-501	
Auxiliary Output/Digital Input/Ethernet Communications PWA	51452816-501	
MCU/Inputs PWA	51452819-501	
Electro-Mechanical Relay	30755306-501	
Open Collector Output PWA	30756679-501	
Solid State Relay	30756725-501	
Current Output PWA	51452804-501	
Dual Electromechanical Relay PWA	51452807-501	
Ethernet Adaptor Board Kit	50009071-501	
Case Assembly (including Mounting Kit with four brackets)	51452759-501	
Varistor (MOV) 120 Vac	30732481-501	
Varistor (MOV) 240 Vac	30732481-502	
4-20 mA Input Resistor Assembly (250 ohm)	30731996-506	
0-10 Volt Input Resistor Assembly (100K pair)	30754465-501	
Mounting Kits (12 Brackets)	51452763-501	
DIN Adaptor Kit	30755223-003	
Process Instrument Explorer Software	50001619-001	
Math Software Upgrade	50004635-501	
SPP Software Upgrade	50004635-502	
Panel Bracket Kit	50004821-501	
Product Information on CD	All Languages	51453375-501
Quick Start Manual (2 page) Standard	English	51-52-25-129
Product Manual	English	51-52-25-119

2.4 Control and Alarm Relay Contact Information

Control Relays

ATTENTION

Control relays operate in the standard control mode (that is, energized when output state is on).

Table 2-2 Control Relay Contact Information

Unit Power	Control Relay Wiring	Control Relay Contact	Output #1 or #2 Indicator Status
Off	N.O.	Open	Off
	N.C.	Closed	
On	N.O.	Open	Off
		Closed	On
	N.C.	Closed	Off
		Open	On

Alarm Relays

ATTENTION

Alarm relays are designed to operate in a failsafe mode (that is, de-energized during alarm state). This results in alarm actuation when power is OFF or when initially applied, until the unit completes self-diagnostics. If power is lost to the unit, the alarms will de-energize and thus the alarm contacts will close.

Table 2-3 Alarm Relay Contact Information

Unit Power	Alarm Relay Wiring	Variable NOT in Alarm State		Variable in Alarm State	
		Relay Contact	Indicators	Relay Contact	Indicators
Off	N.O.	Open	Off	Open	Off
	N.C.	Closed		Closed	
On	N.O.	Closed	Off	Open	On
	N.C.	Open		Closed	

2.5 Mounting

Physical Considerations

The controller can be mounted on either a vertical or tilted panel using the mounting kit supplied. Adequate access space must be available at the back of the panel for installation and servicing activities.

- Overall dimensions and panel cutout requirements for mounting the controller are shown in Figure 2-2.
- The controller's mounting enclosure must be grounded according to CSA standard C22.2 No. 0.4 or Factory Mutual Class No. 3820 paragraph 6.1.5.
- The front panel is moisture rated NEMA3 and IP55 rated and can be easily upgraded to NEMA4X and IP66. (See Mounting Method, page 19)

Overall Dimensions

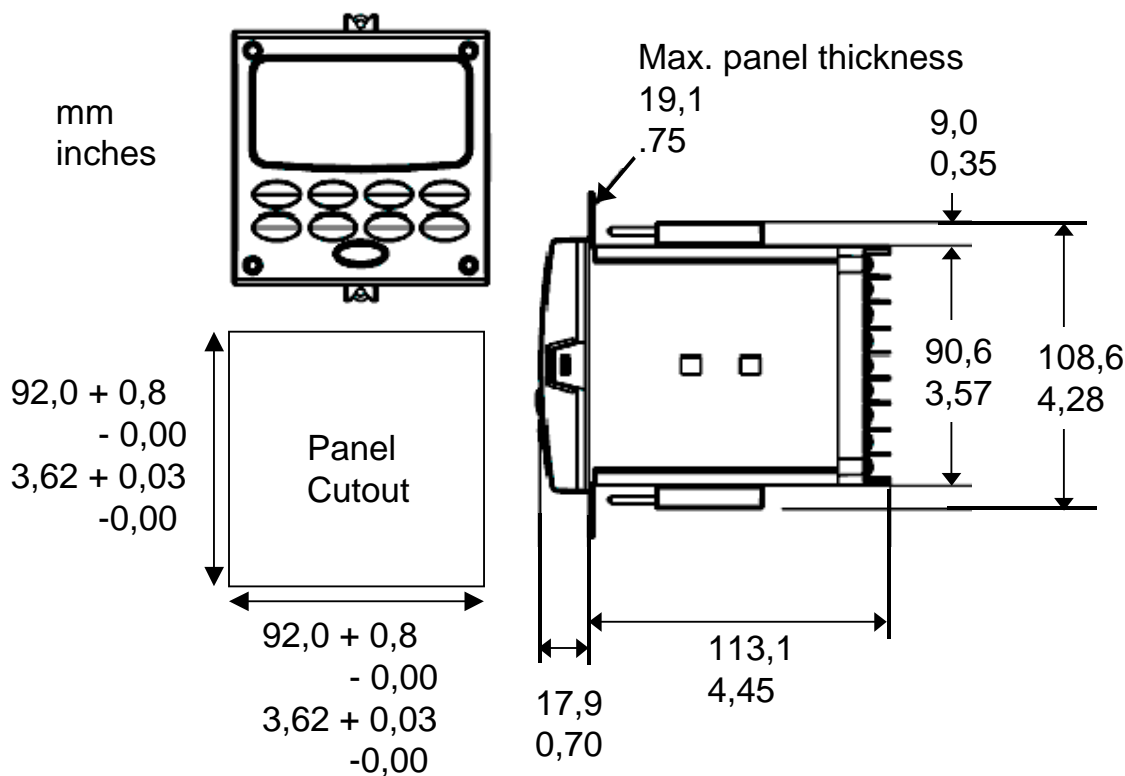

Figure 2-2 Mounting Dimensions (not to scale)

Mounting Notes

Before mounting the controller, refer to the nameplate on the outside of the case and make a note of the model number. It will help later when selecting the proper wiring configuration.

Mounting Method

Before mounting the controller, refer to the nameplate on the outside of the case and make a note of the model number. It will help later when selecting the proper wiring configuration.

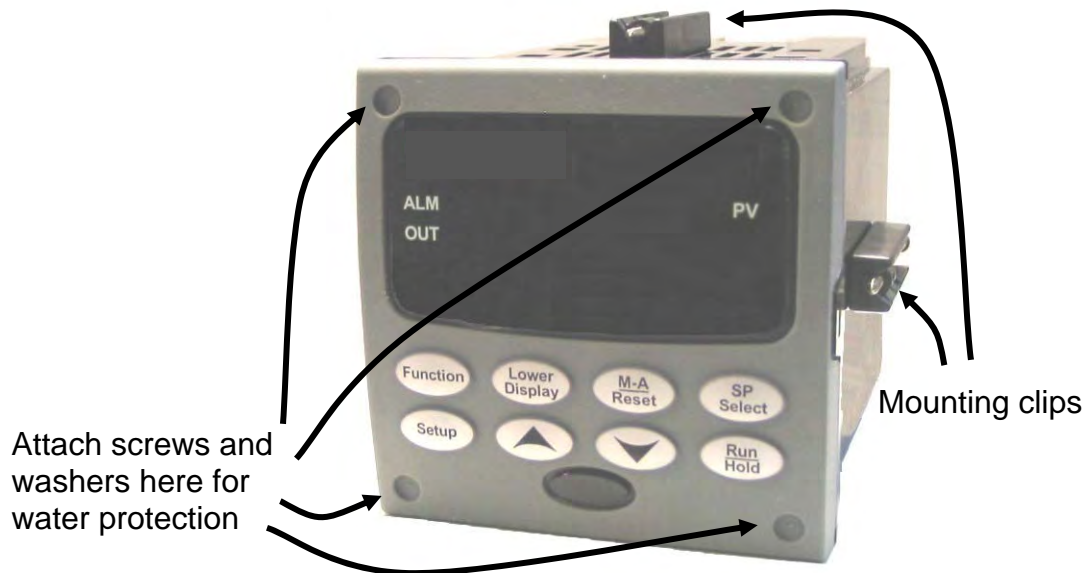

Figure 2-3 Mounting Methods

Mounting Procedure

Table 2-4 Mounting Procedure

Step	Action
1	Mark and cut out the controller hole in the panel according to the dimension information in Figure 2-2.
2	Orient the case properly and slide it through the panel hole from the front.
3	Remove the mounting kit from the shipping container and install the kit as follows: <ul style="list-style-type: none"> For normal (NEMA 3/IP55) installation two mounting clips are required. Insert the prongs of the clips into the two holes in the top and bottom center of the case For water-protected (NEMA 4X/IP66) installation four mounting clips are required. There are two options of where to install the mounting clips: <ol style="list-style-type: none"> 1) Insert the prongs of the clips into the two holes on the left and right side of the top and bottom of the case or 2) on the center on each of the four sides. Tighten screws to 2 lb-inch (22 N•cm) to secure the case against the panel. CAUTION: Over tightening will cause distortion and the unit may not seal properly.
4	For water-protected installation, install four screws with washers into the four recessed areas in the corners of the front bezel (Figure 2-3). Push the point of the screw through the center piercing the elastomeric material and then tighten screws to 5 lb-in (56 N•cm).

2.6 Wiring

2.6.1 Electrical Considerations

Line voltage wiring

This controller is considered “rack and panel mounted equipment” per EN61010-1, Safety Requirements for Electrical Equipment for Measurement, Control, and Laboratory Use, Part 1: General Requirements. Conformity with 72/23/EEC, the Low Voltage Directive requires the user to provide adequate protection against a shock hazard. The user shall install this controller in an enclosure that limits OPERATOR access to the rear terminals.

Mains Power Supply

This equipment is suitable for connection to 90 to 250 Vac or to 24 Vac/dc 50/60 Hz, power supply mains. It is the user’s responsibility to provide a switch and non-time delay (North America), quick-acting, high breaking capacity, Type F (Europe), 1/2A, 250V fuse(s), or circuit-breaker for 90-250 Vac applications; or 1 A, 125 V fuse or circuit breaker for 24 Vac/dc applications, as part of the installation. The switch or circuit-breaker shall be located in close proximity to the controller, *within easy reach of the OPERATOR*. The switch or circuit-breaker shall be marked as the disconnecting device for the controller.

CAUTION

Applying 90-250 Vac to an instrument rated for 24 Vac/dc will severely damage the instrument and is a fire and smoke hazard.

When applying power to multiple instruments, make certain that sufficient current is supplied. Otherwise, the instruments may not start up normally due to the voltage drop caused by the in-rush current.

Controller Grounding

PROTECTIVE BONDING (grounding) of this controller and the enclosure in which it is installed shall be in accordance with National and Local electrical codes. To minimize electrical noise and transients that may adversely affect the system, supplementary bonding of the controller enclosure to a local ground, using a No. 12 (4 mm²) copper conductor, is recommended.

Control/Alarm Circuit Wiring

The insulation of wires connected to the Control/Alarm terminals shall be rated for the highest voltage involved. Extra Low Voltage (ELV) wiring (input, current output, and low voltage Control/Alarm circuits) shall be separated from HAZARDOUS LIVE (>30 Vac, 42.4 V_{peak}, or 60 V_{dc}) wiring per Permissible Wiring Bundling, Table 2-5.

Electrical Noise Precautions

Electrical noise is composed of unabated electrical signals which produce undesirable effects in measurements and control circuits.

Digital equipment is especially sensitive to the effects of electrical noise. Your controller has built-in circuits to reduce the effect of electrical noise from various sources. If there is a need to further reduce these effects:

- *Separate External Wiring*—Separate connecting wires into bundles (See Permissible Wiring Bundling - Table 2-5) and route the individual bundles through separate conduit metal trays.
- *Use Suppression Devices*—For additional noise protection, you may want to add suppression devices at the external source. Appropriate suppression devices are commercially available.

ATTENTION

For additional noise information, refer to document number 51-52-05-01, *How to Apply Digital Instrumentation in Severe Electrical Noise Environments*.

Permissible Wiring Bundling

Table 2-5 Permissible Wiring Bundling

Bundle No.	Wire Functions
1	<ul style="list-style-type: none"> • Line power wiring • Earth ground wiring • Line voltage control relay output wiring • Line voltage alarm wiring
2	<p>Analog signal wire, such as:</p> <ul style="list-style-type: none"> • Input signal wire (thermocouple, 4 to 20 mA, etc.) • 4-20 mA output signal wiring <p>Digital input signals</p>
3	<ul style="list-style-type: none"> • Low voltage alarm relay output wiring • Low voltage wiring to solid state type control circuits • Low voltage wiring to open collector type control circuits

2.7 Wiring Diagrams

Identify Your Wiring Requirements

To determine the appropriate diagrams for wiring your controller, refer to the model number interpretation in this section. The model number of the controller is on the outside of the case.

Universal Output Functionality and Restrictions

Instruments with multiple outputs can be configured to perform a variety of output types and alarms. For example, an instrument with a current output and two relays can be configured to perform any of the following:

- 1) Current Simplex with two alarm relays;
- 2) Current Duplex 100% with two alarm relays;
- 3) Time Simplex with one alarm relay;
- 4) Time Duplex with no alarm relays; or
- 5) Three Position Step Control with no alarm relays.

These selections may all be made via the keyboard and by wiring to the appropriate output terminals; there are no internal jumpers or switches to change. This flexibility allows a customer to stock a single instrument which is able to handle a variety of applications.

Table 2-6 shows what control types and alarms are available based upon the installed outputs. In this table, when Duplex Control and Reverse Action are configured, “Output 1” is HEAT while “Output 2” is COOL. When Three Position Step Control is configured, “Output 1” is OPEN while “Output 2” is CLOSE. The Output 1/2 option “Single Relay” can be any of the following selections: Electro-Mechanical Relay, Solid-State Relay or Open Collector Output.

Table 2-6 Universal Output Functionality and Restrictions

Output Algorithm Type	Output 1/2 Option	Function of Output 1/2	Function of Other Outputs		
			Output #3	Output #4	Auxiliary Output
Time Simplex	Single Relay	Output 1	Alarm 2	Alarm 1	Not Needed
	Current Output	INU	Output 1	Alarm 1	Not Needed
	Dual Relay	Output 1	Alarm 2	Alarm 1	Not Needed
Time Duplex or TPSC or Position Proportional	Single Relay	Output 1	Output 2	Alarm 1	Not Needed
	Current Output	INU	Output 2	Output 1	Not Needed
	Dual Relay	Outputs 1 and 2	Alarm 2	Alarm 1	Not Needed
Current Simplex	Single Relay	INU	Alarm 2	Alarm 1	Output 1
	Current Output	Output 1	Alarm 2	Alarm 1	Not Needed
	Dual Relay	INU	Alarm 2	Alarm 1	Output 1
Current Dup. 100% Current = COOL and HEAT	Single Relay	INU	Alarm 2	Alarm 1	Outputs 1 and 2
	Current Output	Outputs 1 and 2	Alarm 2	Alarm 1	Not Needed
	Dual Relay	INU	Alarm 2	Alarm 1	Outputs 1 and 2
Current Duplex 50% Current = HEAT Aux Out = COOL	Single Relay	N/A	N/A	N/A	N/A
	Current Output	Output 1	Alarm 2	Alarm 1	Output 2
	Dual Relay	N/A	N/A	N/A	N/A
Current/Time Current = COOL Time = HEAT	Single Relay *	Output 1	Output 2	Alarm 1	Output 2
	Current Output	Output 2	Output 2	Alarm 1	Not Needed
	Dual Relay *	Outputs 1 & 2	Alarm 2	Alarm 1	Output 2
Time/Current Time = COOL Current = HEAT	Single Relay *	Output 1	Output 2	Alarm 1	Output 1
	Current Output	Output 1	Output 2	Alarm 1	Not Needed
	Dual Relay *	Outputs 1 & 2	Alarm 2	Alarm 1	Output 1

TPSC = Three Position Step Control

N/A = Not Available – This output algorithm type cannot be performed with this Output 1/2 option.

INU = Installed, Not Used – The installed Output 1/2 option is not used for the configured output algorithm type.

Not Needed = Auxiliary Output is Not Needed to provide the desired output algorithm and can be used for another purpose. With the proper configuration, Auxiliary Output could also be used as a substitute for the Current Output.

* To obtain this output algorithm type with these Output 1/2 Options: 1) Configure the OUTALG selection as “TIME D”; 2) Configure Auxiliary Output for “OUTPUT” and; 3) Scale the Auxiliary Output as necessary for the desired output algorithm type. For these

selections, the Output 1 (HEAT) and Output 2 (COOL) signals will be present both on the Auxiliary Output and on the two relays normally used for Time Duplex.

Wiring the Controller

Using the information contained in the model number, select the appropriate wiring diagrams from the composite wiring diagram below. Refer to the individual diagrams listed to wire the controller according to your requirements.

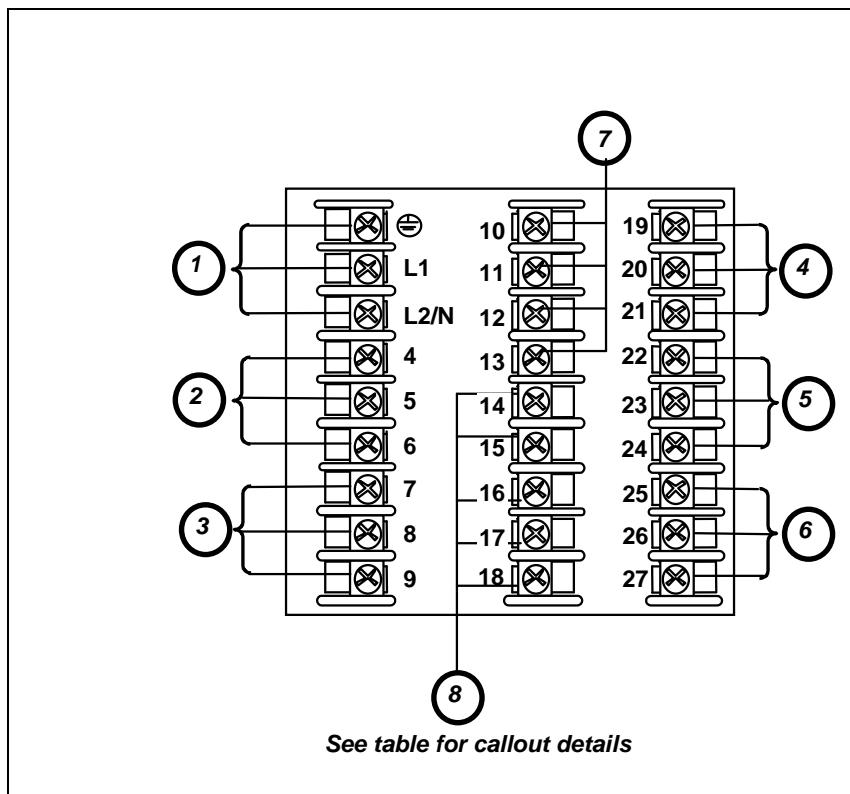

Figure 2-4 Composite Wiring Diagram

Callout	Details
1	AC/DC Line Voltage Terminals. See Figure 2-5.
2	Output 3 Terminals. See Figure 2-8 through Figure 2-14.
3	Output 4 Terminals. See Figure 2-8 through Figure 2-14.
4	Outputs 1 and 2 Terminals. See Figure 2-8 through Figure 2-14.
5	Input #2 Terminals. See Figure 2-7.
6	Input #1 Terminals. See Figure 2-6.
7	Aux. Output and Digital Inputs Terminals. See Figure 2-17.
8	Communications Terminals. See Figure 2-15 and Figure 2-16.

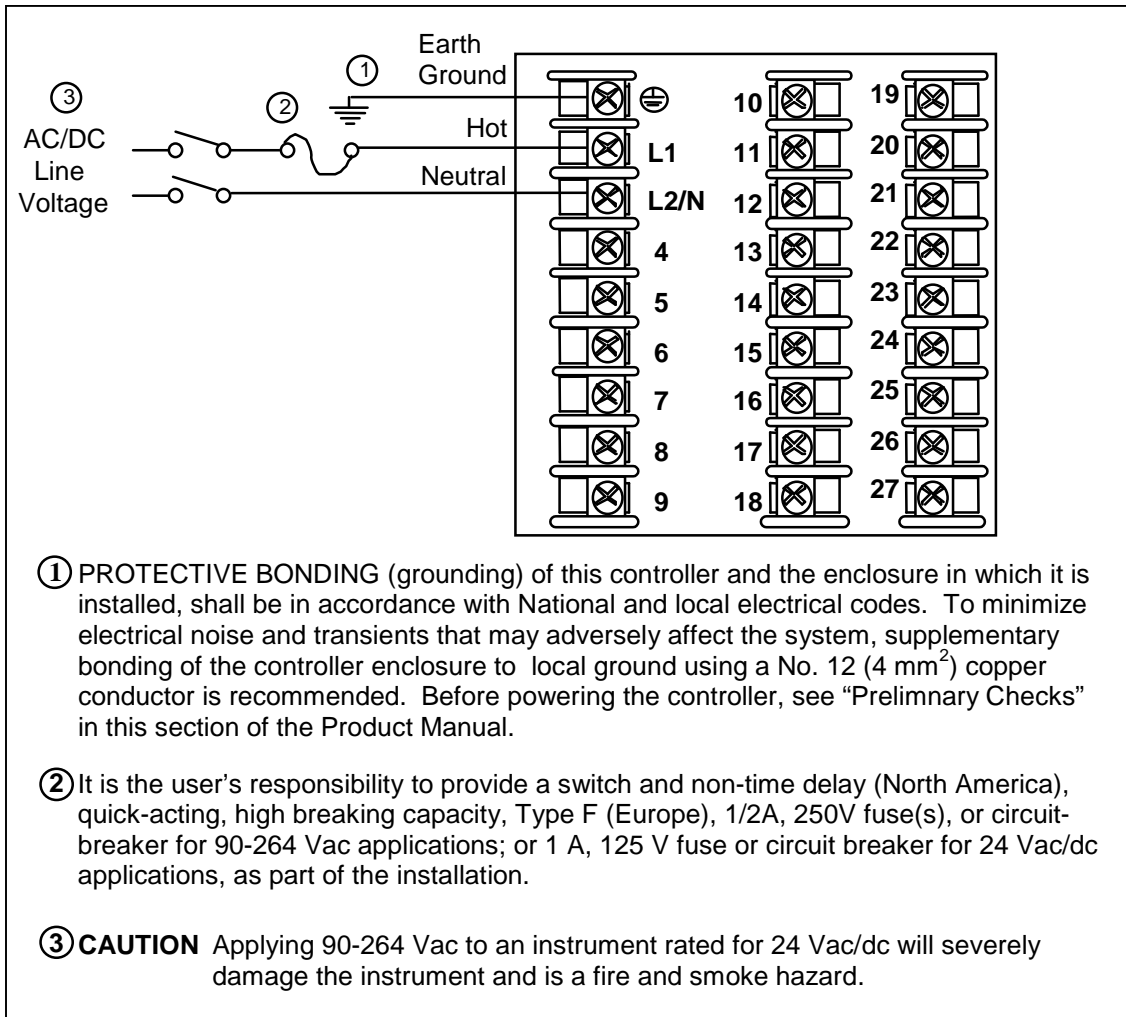
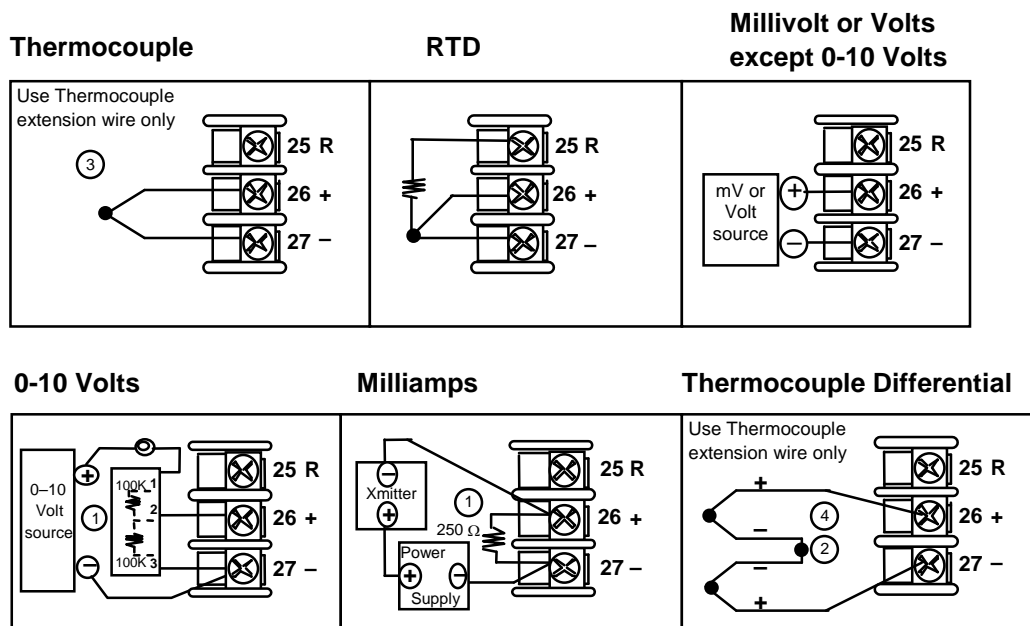

Figure 2-5 Mains Power Supply

Input #1



- ① The 250 ohm resistor for milliamp inputs or the voltage divider for 0-10 Volt inputs are supplied with the controller when those inputs are specified. These items must be installed prior to start up when the controller is wired. For 0-20 mA applications, the resistor should be located at the transmitter terminals if Burnout detection is desired.
- ② Splice and tape this junction between the two thermocouples. This junction may be located anywhere between the thermocouples and the instrument terminals, it does not need to be close to the other thermocouple junctions. Both thermocouples must be of the same type. For best accuracy, the two thermocouples should be matched or, preferably, made from the same batch of wire.
- ③ This controller does not produce a steady current for burnout detection. For that reason, when a thermocouple is used in parallel with another instrument, it may be desirable to configure the burnout selection for this controller to "NOFS" and use the burnout current from the other instrument to also drive this controller.
- ④ The millivolt values for the Thermocouple Differential Input are for a pair of J thermocouples at an ambient temperature mean of 450°F / 232°C.

Figure 2-6 Input 1 Connections

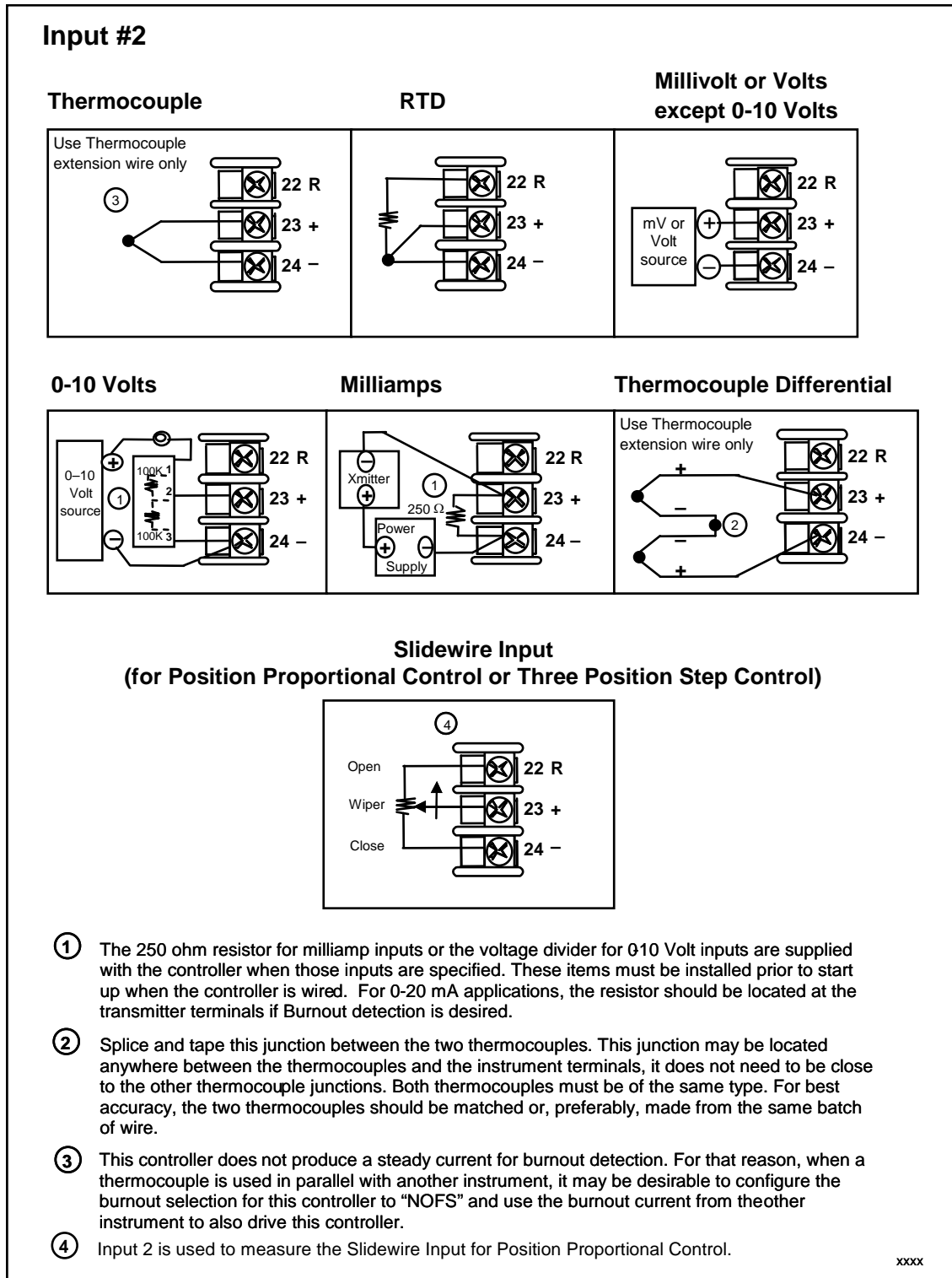

Figure 2-7 Input 2 Connections

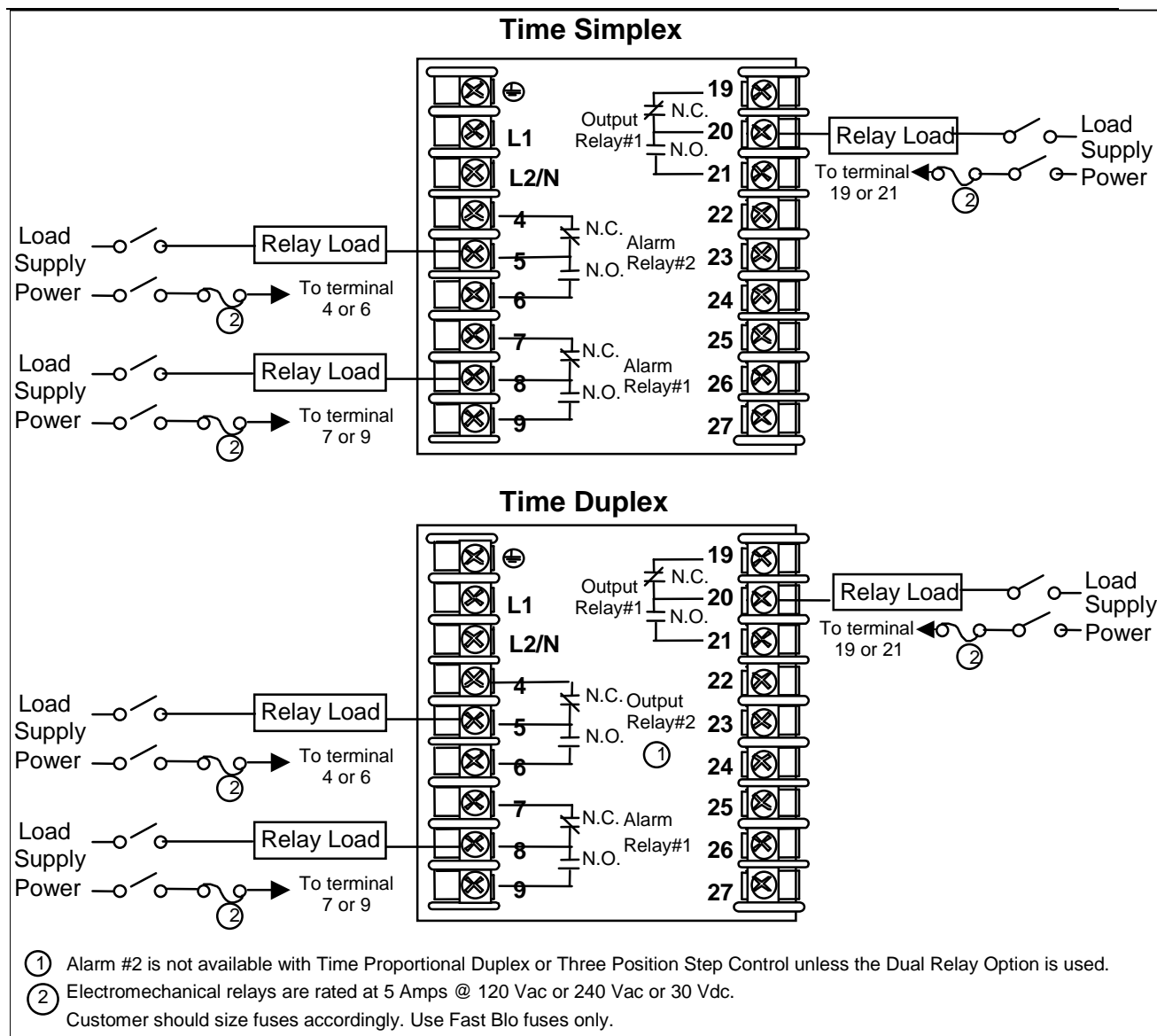

Figure 2-8 Electromechanical Relay Output

See Table 2-6 for relay terminal connections for other Output Algorithm Types.

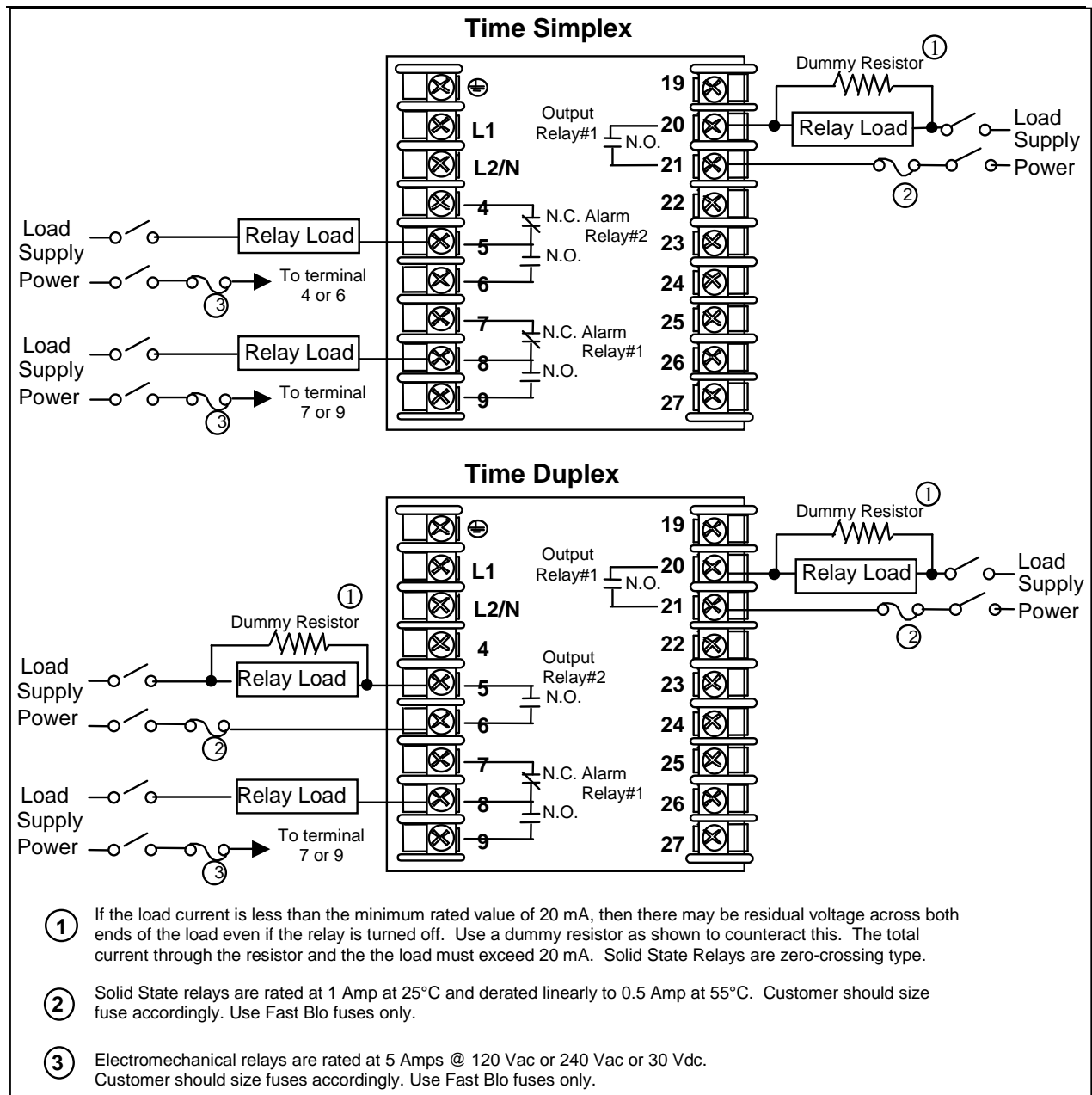

Figure 2-9 Solid State Relay Output

See Table 2-6 for relay terminal connections for other Output Algorithm Types.

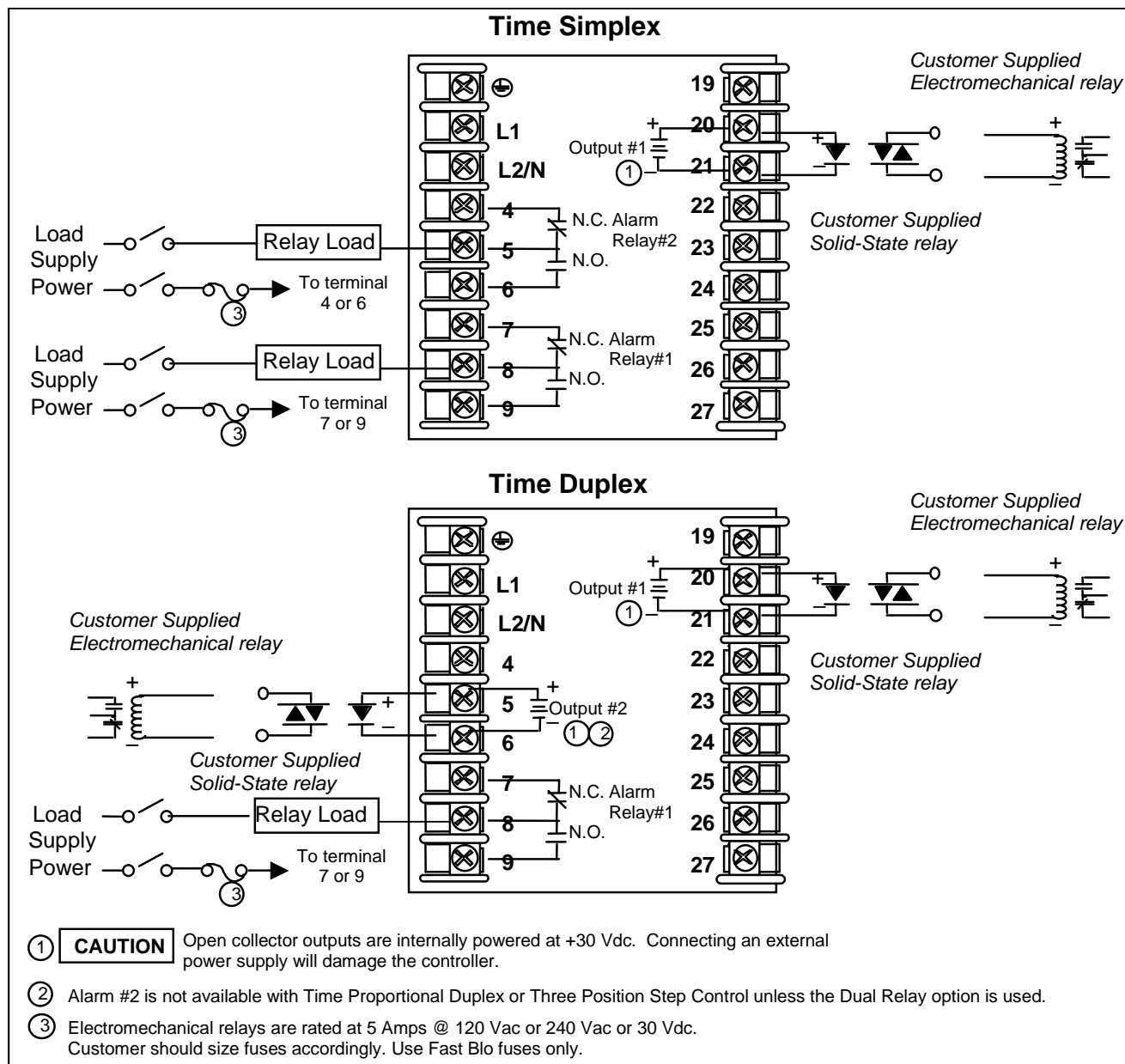

Figure 2-10 Open Collector Output

See Table 2-6 for relay terminal connections for other Output Algorithm Types.

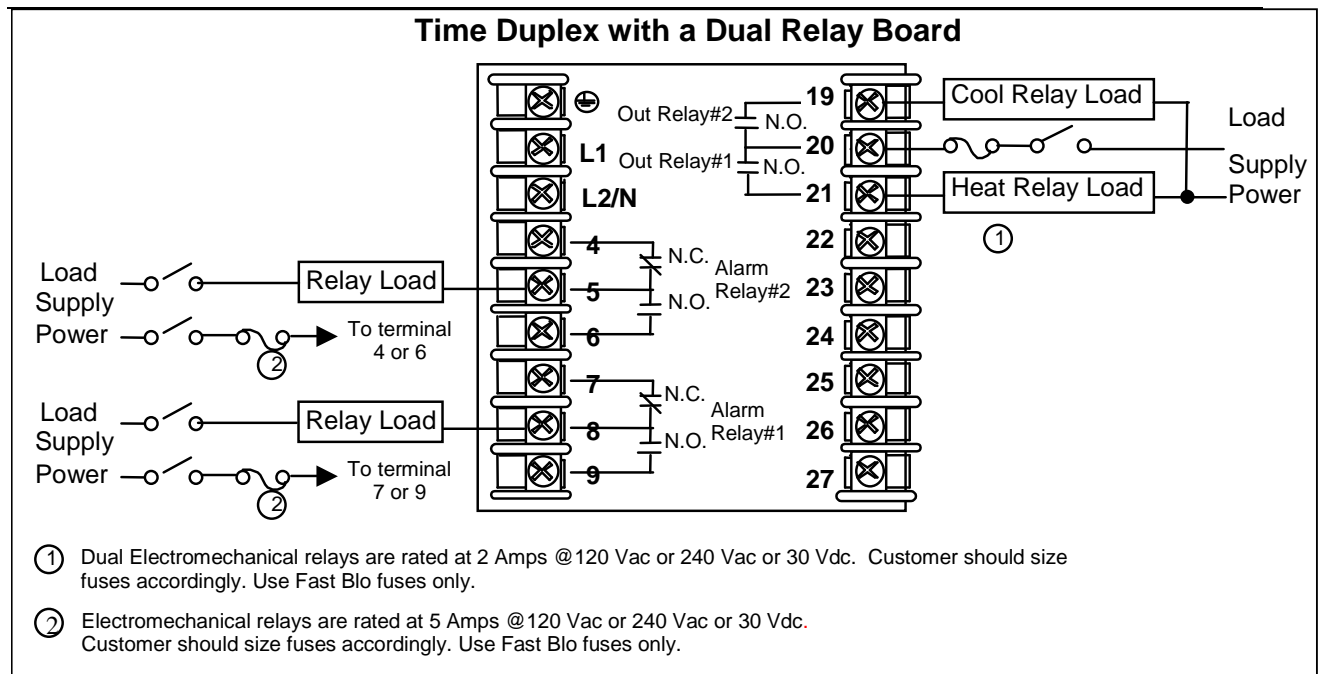

Figure 2-11 Dual Electromechanical Relay Option Output

See Table 2-6 for relay terminal connections for other Output Algorithm Types.

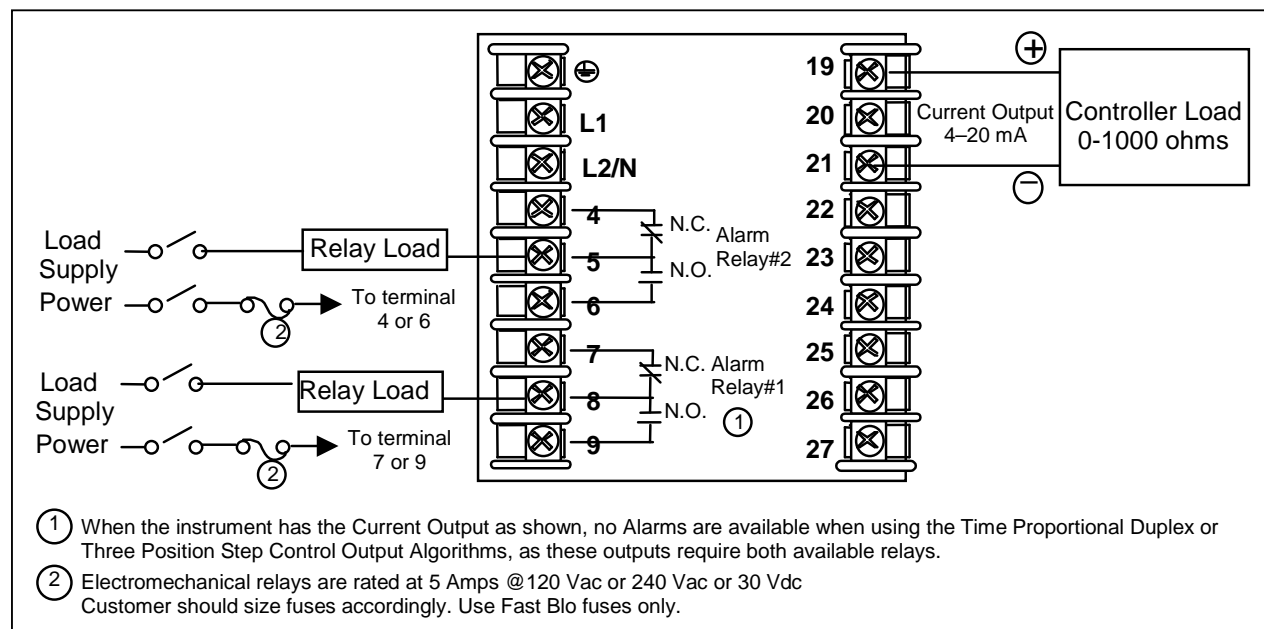

Figure 2-12 Current Output

See Table 2-6 for relay terminal connections for other Output Algorithm Types.

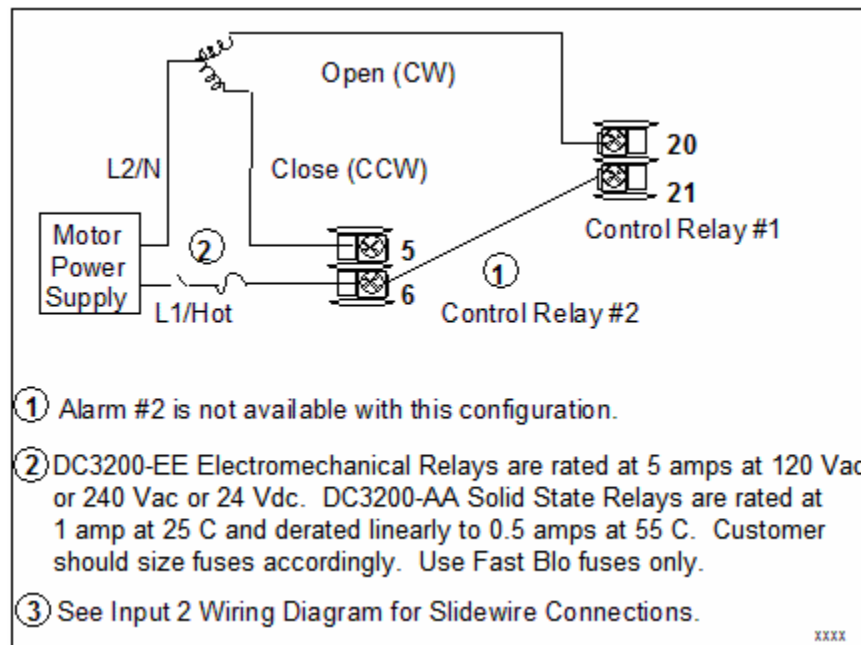

Figure 2-13 Position Proportional or Three Position Step Control Connections, models DC3200-EE or DC3200-AA

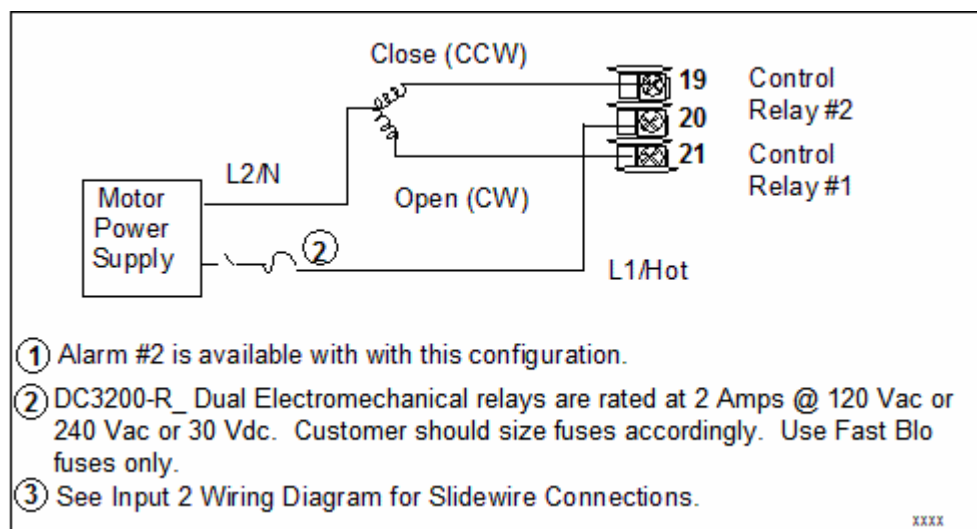

Figure 2-14 Position Proportional or Three Position Step Control Connections, model DC3200-R_

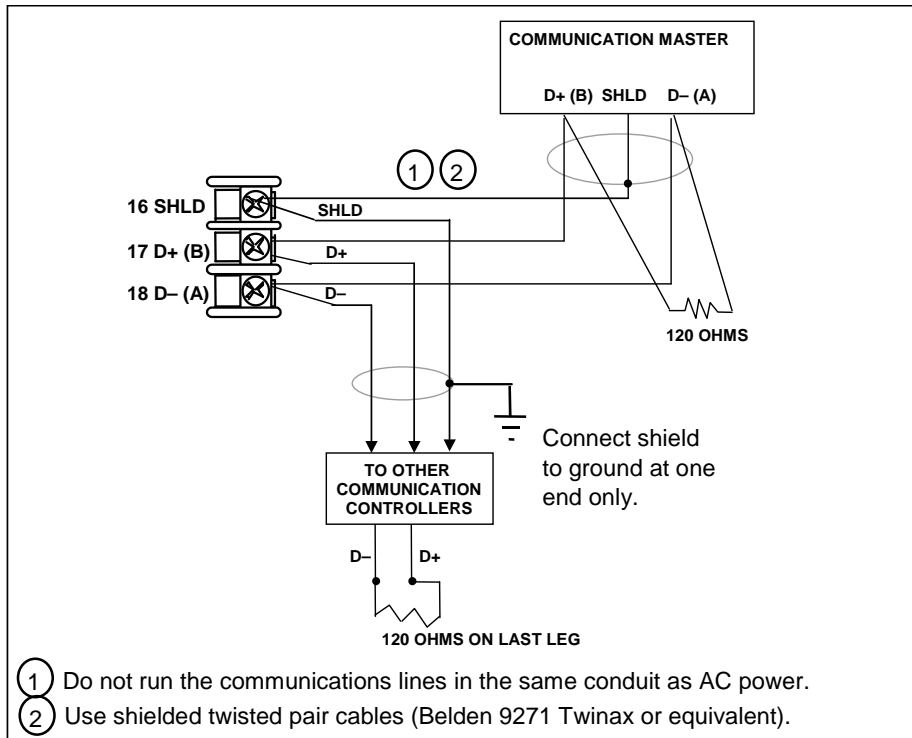

Figure 2-15 RS-422/485 Communications Option Connections

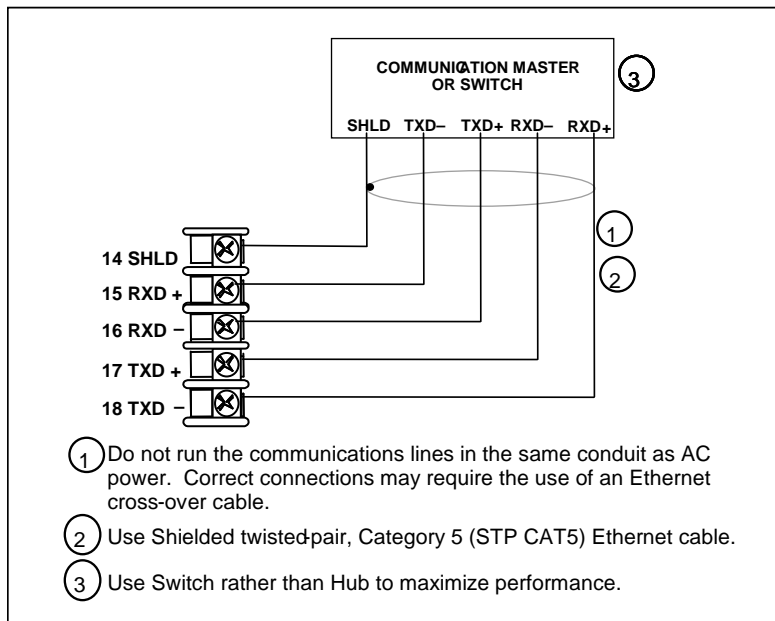

Figure 2-16 Ethernet Communications Option Connections

Figure 2-16 and Table 2-7 shows how to connect a UDC to a MDI Compliant Hub or Switch utilizing a **straight-through cable** or for connecting a UDC to a PC utilizing a **crossover cable**.

Table 2-7 Terminals for connecting a UDC to a MDI Compliant Hub or Switch

UDC Terminal	UDC Signal Name	RJ45 Socket Pin #	Switch Signal Name
Position 14	Shield	Shield	Shield
Position 15	RXD-	6	TXD-
Position 16	RXD+	3	TXD+
Position 17	TXD-	2	RXD-
Position 18	TXD+	1	RXD+

Table 2-8 shows how to connect a UDC directly to a PC utilizing a straight-through cable (wiring the UDC cable this way makes the necessary cross-over connections)

Table 2-8 Terminals for connecting a UDC directly to a PC utilizing a straight-through cable

UDC Terminal	UDC Signal Name	RJ45 Socket Pin #	PC Signal Name
Position 14	Shield	Shield	Shield
Position 15	RXD-	2	TXD-
Position 16	RXD+	1	TXD+
Position 17	TXD-	6	RXD-
Position 18	TXD+	3	RXD+

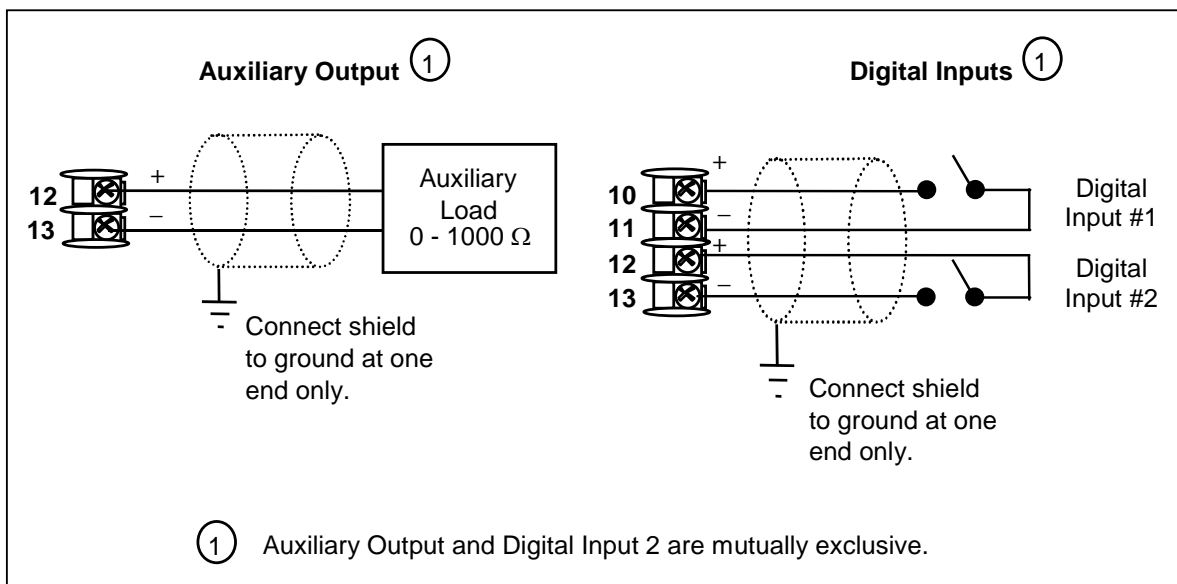

Figure 2-17 Auxiliary Output and Digital Inputs Option Connections

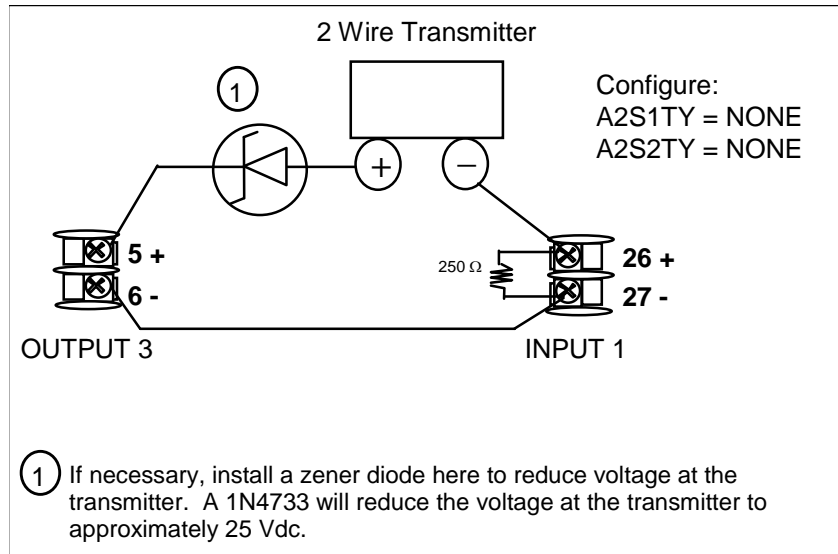

Figure 2-18 Transmitter Power for 4-20 mA — 2 wire Transmitter Using Open Collector Alarm 2 Output

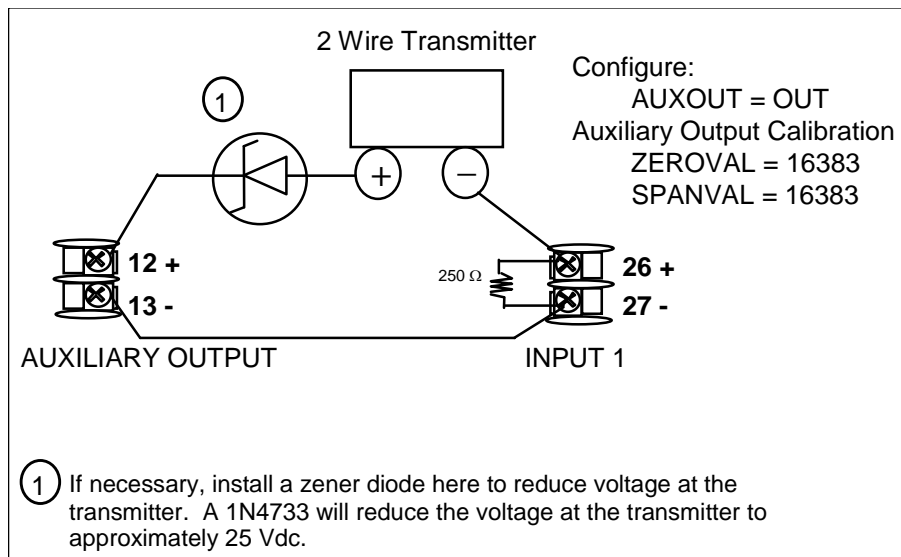

Figure 2-19 Transmitter Power for 4-20 mA — 2 Wire Transmitter Using Auxiliary Output

3 Configuration

3.1 Overview

Introduction

Configuration is a dedicated operation where you use straightforward keystroke sequences to select and establish (configure) pertinent control data best suited for your application.

To assist you in the configuration process, there are prompts that appear in the upper and lower displays. These prompts let you know what group of configuration data (Set Up prompts) you are working with and also, the specific parameters (Function prompts) associated with each group.

Table 3-1 shows an overview of the prompt hierarchy as it appears in the controller.

What's in this section?

The following topics are covered in this section.

Table 3-1 Configuration Topics

TOPIC	See Page
3.1 Overview	37
3.2 Configuration Prompt Hierarchy	38
3.3 Configuration Procedure	40
3.4 Tuning Set Up Group	41
3.5 SP Ramp Set Up Group	45
3.6 Accutune Set Up Group	49
3.7 Algorithm Set Up Group	51
3.8 Output Set Up Group	61
3.9 Input 1 Set Up Group	65
3.10 Input 2 Set Up Group	69
3.11 Control Set Up Group	72
3.12 Options Set Up Group	79
3.13 Communications Set Up Group	85
3.14 Alarms Set Up Group	88
3.15 Display Set Up Group	93
3.16 Configuration Record Sheet	95

3.2 Configuration Prompt Hierarchy

Table 3-2 Configuration Prompt Hierarchy

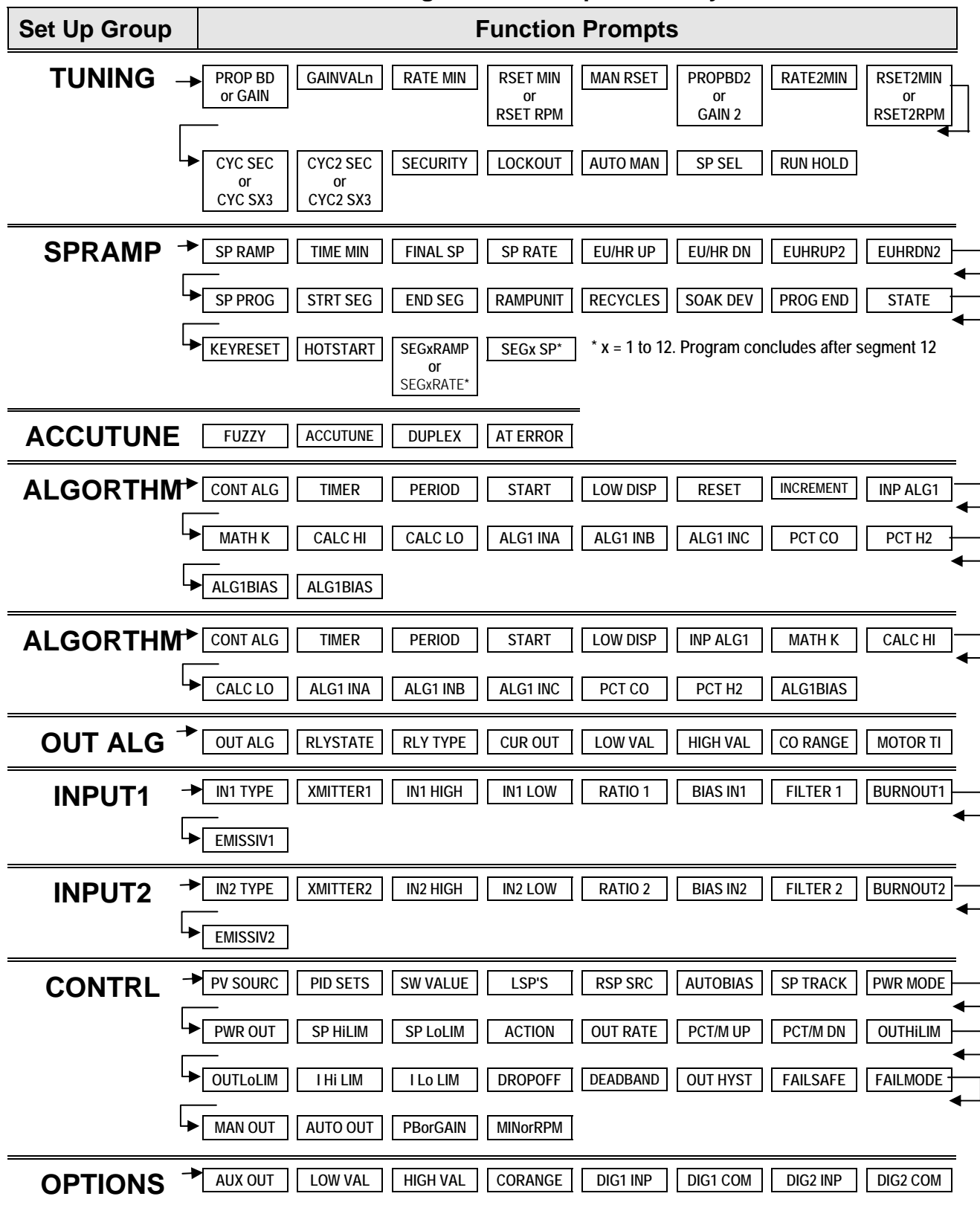

Set Up Group	Function Prompts
COM	Com ADDR ComSTATE IR ENABLE BAUD TX DELAY WSFLOAT SHEDENAB SHEDTIME SHEDMODE SHEDSP UNITS CSP RATO CSP BIAS LOOPBACK
ALARMS	A1S1TYPE A1S1 VAL A1S1 H L A1S1 EV A1S2 TYPE A1S2 VAL A1S2 H L A1S2 EV A2S1TYPE A2S1 VAL A2S1 H L A2S1 EV A2S2TYPE A2S2 VAL A2S2 H L A2S2 EV AL HYST ALM OUT1 BLOCK DIAGNOST
DISPLAY	DECIMAL TEMPUNIT PWR FREQ RATIO 2 LANGUAGE
CALIB	→ USED FOR FIELD CALIBRATION
STATUS	VERSION FAILSAFE TESTS

3.3 Configuration Procedure

Introduction

Each of the Set Up groups and their functions are pre-configured at the factory. The factory settings are shown in Table 3-4 through Table 3-14 that follow this procedure.

If you want to change any of these selections or values, follow the procedure in Table 3-3. This procedure tells you the keys to press to get to any Set Up group and any associated Function parameter prompt.

Procedure

ATTENTION











The prompting scrolls at a rate of 2/3 seconds when the **SET UP** or **FUNCTION** key is held in. Also,  or  keys will move group prompts forward or backward at a rate twice as fast.

Table 3-3 Configuration Procedure

Step	Operation	Press	Result
1	Enter Set Up Mode		<i>Upper Display</i> = SETUP <i>Lower Display</i> = TUNING (This is the first Set Up Group title)
2	Select any Set Up Group		Sequentially displays the other Set Up group titles shown in the prompt hierarchy in Table 3-2 Configuration Prompt Hierarchy. You can also use the  or  keys to scan the Set Up groups in both directions. Stop at the Set Up group title that describes the group of parameters you want to configure. Then proceed to the next step.
3	Select a Function Parameter		<i>Upper Display</i> = the current value or selection for the first function prompt of the selected Set Up group. <i>Lower Display</i> = the first Function prompt within that Set Up group. Sequentially displays the other function prompts of the Set Up group you have selected. Stop at the function prompt that you want to change, then proceed to the next step.
4	Change the Value or Selection	 or 	Increments or decrements the value or selection that appears for the selected function prompt. If you change the value or selection of a parameter while in Set Up mode but then decide not to enter it, press the MAN/AUTO key once. This will recall the original configuration. This "recall" procedure does not work for a Field Calibration process. Field Calibration is a one-way operation.
5	Enter the Value or Selection		Enters value or selection made into memory after another key is pressed.
6	Exit Configuration		Exits configuration mode and returns controller to the same state it was in immediately preceding entry into the Set Up mode. It stores any changes you have made. If you do not press any keys for 30 seconds, the controller times out and reverts to the mode and associated display used prior to entry into Set Up mode.

3.4 Tuning Set Up Group

Introduction

Tuning consists of establishing the appropriate values for the tuning constants you are using so that your controller responds correctly to changes in process variable and setpoint. You can start with predetermined values but you will have to watch the system to see how to modify them. The Accutune feature automatically selects Gain, Rate, and Reset on demand.

ATTENTION

Because this group contains functions that have to do with security and lockout, we recommend that you configure this group last, after all other configuration data has been loaded.

Function Prompts

Table 3-4 TUNING Group Function Prompts

Function Prompt Lower Display	Selections or Range of Setting Upper Display	Parameter Definition
PROP BD or GAIN	0.1 to 9999 % or 0.001 to 1000	<p>PROPORTIONAL BAND (simplex) is the percent of the range of the measured variable for which a proportional controller will produce a 100 % change in its output.</p> <p>GAIN is the ratio of output change (%) over the measured variable change (%) that caused it.</p> $G = \frac{100\%}{PB\%}$ <p>where PB is the proportional band (in %)</p> <p>If the PB is 20 %, then the Gain is 5. And, at those settings, a 3 % change in the error signal (SP-PV) will result in a 15 % change in the controller's output due to proportional action. If the Gain is 2, then the PB is 50 %.</p> <p>Also defined as "HEAT" Gain on Duplex models for variations of Heat/Cool applications.</p> <p><i>The selection of Proportional Band or Gain is made in the CONTROL parameter group under prompt PBoRGAIn.</i></p>
RATE MIN	0.00 to 10.00 minutes	<p>RATE action, in minutes, affects the controller's output whenever the deviation is changing; and affects it more when the deviation is changing faster.</p> <p>Also defined as "HEAT" Rate on Duplex models for variations of Heat/Cool applications.</p>

Function Prompt Lower Display	Selections or Range of Setting Upper Display	Parameter Definition
<p>RSET MIN or RSET RPM</p>	<p>0.02 to 50.00</p>	<p>RSET MIN = Reset in Minutes per Repeat RSET RPM = Reset in Repeats per Minute</p> <p>RESET (or Integral Time) adjusts the controller's output in accordance with both the size of the deviation (SP–PV) and the time that it lasts. The amount of the corrective action depends on the value of Gain. The Reset adjustment is measured as how many times proportional action is repeated per minute or how many minutes before one repeat of the proportional action occurs.</p> <p>Used with control algorithm PID-A or PID-B. Also defined as "HEAT" Reset on Duplex models for variations of Heat/Cool applications.</p> <p>ATTENTION The selection of whether Minutes per Repeat or Repeats per Minute is used is made in the CONTROL parameters group under the prompt MINorRPM.</p>
<p>MAN RSET</p>	<p>–100 to +100 (in % output)</p>	<p>MANUAL RESET is only applicable if you use control algorithm PD WITH MANUAL RESET in the Algorithm Set Up group. Because a proportional controller will not necessarily line out at setpoint, there will be a deviation (offset) from setpoint. This eliminates the offset and lets the PV line out at setpoint.</p> <p>ATTENTION Bias is shown on the lower display.</p>
<p>PROPB2 or GAIN 2</p>	<p>0.1 to 9999 % or 0.001 to 1000</p>	<p>PROPORTIONAL BAND 2 or GAIN 2, RATE 2, and RESET 2 parameters are the same as previously described for "Heat" except that they refer to the cool zone tuning constants on duplex models or the second set of PID constants, whichever is pertinent.</p>
<p>RATE2MIN</p>	<p>0.00 to 10.00 minutes</p>	<p>This is the same as above except that it applies to Duplex models for the "COOL" zone of Heat/Cool applications or for the second set of PID constants.</p>
<p>RSET2MIN RSET2RPM</p>	<p>0.02 to 50.00</p>	<p>These are the same as above except that they apply to Duplex models for the "COOL" zone of Heat/Cool applications or for the second set of PID constants.</p>

Function Prompt Lower Display	Selections or Range of Setting Upper Display	Parameter Definition
<p>CYC SEC or CYC SX3</p>	<p>1 to 120</p>	<p>CYCLE TIME (HEAT) determines the length of one time proportional output relay cycle. Defined as "HEAT" cycle time for Heat/Cool applications.</p> <p>CYC SEC—Electromechanical relays CYC SX3—Solid state relays</p> <p>ATTENTION <i>Cycle times are in either second or 1/3-second increments depending upon the configuration of RLY TYPE in the Output Algorithm Set Up group.</i></p>
<p>CYC2 SEC or CYC2 SX3</p>	<p>1 to 120</p>	<p>CYCLE TIME 2 (COOL) is the same as above except it applies to Duplex models as the cycle time in the "COOL" zone of Heat/Cool applications or for the second set of PID constants.</p> <p>CYC2 SEC—Electromechanical relays CYC2 SX3—Solid state relays</p> <p>ATTENTION <i>Cycle times are in either second or 1/3-second increments depending upon the configuration of RLY TYPE in the Output Algorithm Set Up group.</i></p>
<p>SECURITY</p>	<p>0 to 9999</p>	<p>SECURITY CODE—The level of keyboard lockout may be changed in the Set Up mode. Knowledge of a security code may be required to change from one level to another. This configuration should be copied and kept in a secure location.</p> <p>NOTE: The Security Code is for keyboard entry only and is not available via communications.</p> <p>ATTENTION <i>Can only be changed if LOCKOUT selection is NONE.</i></p>
<p>LOCKOUT</p>	<p>NONE CALIB + CONF + VIEW</p>	<p>LOCKOUT applies to one of the functional groups: Configuration, Calibration, Tuning, Accutune. DO NOT CONFIGURE UNTIL ALL CONFIGURATION IS COMPLETE.</p> <p>NONE—No lockout; all groups are read/write.</p> <p>CALIB—All groups are available for read/write except for the Calibration and Keyboard Lockout groups.</p> <p>+ CONF—Tuning, SP Ramp, and Accutune groups are read/write. All other groups are read only. Calibration and Keyboard Lockout groups are not available.</p> <p>+ VIEW—Tuning and Setpoint Ramp parameters are read/write. No other parameters are viewable.</p>

Function Prompt Lower Display	Selections or Range of Setting Upper Display	Parameter Definition
	MAX	MAX —Tuning and Setpoint Ramp parameters are available for read only. No other parameters are viewable.
AUTO MAN	DISABLE ENABLE	<p>MANUAL/AUTO KEY LOCKOUT—Allows you to disable the Manual/Auto key</p> <p>DISABLE ENABLE</p> <p>ATTENTION <i>Can only be viewed if LOCKOUT is configured for NONE.</i></p>
RUN HOLD	DISABLE ENABLE	<p>RUN/HOLD KEY LOCKOUT—Allows you to disable the Run/Hold key, for either SP Ramp or SP Program. <i>The Run/Hold key is never disabled when used to acknowledge a latched alarm 1</i></p> <p>DISABLE ENABLE</p> <p>ATTENTION <i>Can only be viewed if LOCKOUT is configured for NONE.</i></p>
SP SEL	DISABLE ENABLE	<p>SETPOINT SELECT KEY LOCKOUT—Allows you to disable the Setpoint Select key</p> <p>DISABLE ENABLE</p> <p>ATTENTION <i>Can only be viewed if LOCKOUT is configured for NONE.</i></p>

3.5 SP Ramp Set Up Group

Introduction

Set Point Ramp, Set Point Programs and Set Point Rates can be configured in this group.

A single *Setpoint Ramp* [SP RAMP] can be configured to occur between the current local setpoint and a final local setpoint over a time interval of from 1 to 255 minutes.

A *Set Point Rate* [SPRATE] lets you configure a *specific rate of change* for any local setpoint change.

A single *Set Point Program* [SP PROG] with up to 12 segments can be configured.

For more information on Set Point Rate, Ramp and Programming, see Sections 4.17 through 4.20.

You can start and stop the ramp/program using the **RUN/HOLD** key.

PV Hot Start is a configurable feature and means that, at initialization, the setpoint is set to the current PV value and the Ramp or Rate or Program then starts from this value.

Function Prompts

Table 3-5 SPRAMP Group Function Prompts

Function Prompt Lower Display	Selections or Range of Setting Upper Display	Parameter Definition
<p>SP RAMP</p> <p><i>SP Program must be disabled for SP Ramp prompts to appear</i></p>	<p>DISABLE</p> <p>ENABLE</p>	<p>SINGLE SETPOINT RAMP—Make a selection to enable or disable the setpoint ramp function. Make sure you configure a ramp time and a final setpoint value.</p> <p><i>SP Programming must be disabled.</i></p> <p>DISABLE SETPOINT RAMP—Disables the setpoint ramp option.</p> <p>ENABLE SETPOINT RAMP—Allows the single setpoint ramp prompts to be shown.</p>
<p>TIME MIN</p>	<p>0 to 255 minutes</p>	<p>SETPOINT RAMP TIME—Enter the number of minutes desired to reach the final setpoint. A ramp time of “0” implies an immediate change of setpoint.</p>

Function Prompt Lower Display	Selections or Range of Setting Upper Display	Parameter Definition
FINAL SP	Within setpoint limits	<p>SETPOINT RAMP FINAL SETPOINT—Enter the value desired for the final setpoint. The controller will operate at the setpoint set here when ramp is ended.</p> <p>ATTENTION If the ramp is on HOLD, the held setpoint can be changed by the ▲ and ▼ keys. However, the ramp time remaining and original ramp rate is not changed. Therefore, when returning to RUN mode, the setpoint will ramp at the same rate as previous to the local setpoint change and will stop if the final setpoint is reached before the time expires. If the time expires before the final setpoint is reached, it will jump to the final setpoint.</p> <p>ATTENTION SP RAMP and SP RATE will cause the SP portion of Accutune to abort. PV Tune will continue to function normally. Ramp is placed into HOLD while tuning (TUNE configuration).</p>
HOTSTART	DISABLE ENABLE	<p>DISABLE—LSP1 is used as the initial ramp setpoint. ENABLE—Current PV value is used as the initial ramp setpoint.</p>
<p>SP RATE</p> <p><i>SP Rate operates only when both SP Ramp and SP Programming are in HOLD mode or when both SP Ramp and SP Programming are disabled.</i></p>	DISABLE ENABLE	<p>SETPOINT RATE—Lets you configure a specific rate of change for any local setpoint change.</p> <p>DISABLE SETPOINT RATE—Disables the setpoint rate option.</p> <p>ENABLE SETPOINT RATE—Allows the SP rate feature.</p>
EU/HR UP	0 to 9999 in engineering units per hour	<p>RATE UP—Rate up value. When making a setpoint change, this is the rate at which the controller will change from the original setpoint up to the new one. The ramping (current) setpoint can be viewed as SPn in the lower display.</p> <p>Entering a 0 will imply an immediate step change in Setpoint (i.e., no rate applies).</p>
EU/HR DN	0 to 9999 in engineering units per hour	<p>RATE DOWN—Rate down value. When making a setpoint change, this is the rate at which the controller will change from the original setpoint down to the new one. The ramping (current) setpoint can be viewed as SPn in the lower display.</p> <p>Entering a 0 will imply an immediate step change in Setpoint (i.e., no rate applies).</p>

Function Prompt Lower Display	Selections or Range of Setting Upper Display	Parameter Definition
<p>SP PROG (optional feature)</p> <p><i>SP Ramp must be disabled for SP Program prompts to appear. If SP Rate is enabled, it does not operate while an SP Program is running.</i></p>	<p>DISABLE ENABLE</p>	<p>SETPOINT RAMP/SOAK PROGRAM—Available only with controllers that contain this option.</p> <p><i>SP RAMP must be disabled.</i></p> <p>DISABLE—Disables setpoint programming. ENABLE—Enables setpoint programming.</p> <p>ATTENTION Detailed information for the prompts for SP Programming may be found <i>Section 4.17</i> The listing below is only for reference purposes.</p>
STRT SEG	1 to 11	Start Segment Number
END SEG	2 to 12 even numbers Always end in a soak segment (2, 4, ... 12)	End Segment Number
RAMPUNIT	<p>TIME EU/MIN EU/HR</p>	<p>RAMPUNIT—Engineering Units for Ramp Segments</p> <p>TIME in hours: minutes RATE in Engineering units per minute RATE in Engineering units per hour</p>
RECYCLES	0 to 99 recycles	Number of Program Recycles
SOAK DEV	0 to 99 The number selected will be the PV value (in engineering units) above or below the setpoint outside of which the timer halts.	Guaranteed Soak Deviation Value
PROG END	<p>LASTSP (Hold at last setpoint in the program) F SAFE (Manual mode/Failsafe output)</p>	Program Termination State
STATE	<p>DISABLE HOLD</p>	Program State at Program End
KEYRESET	<p>DISABLE ToBEGIN RERUN</p>	Reset/Rerun SP Program
HOTSTART	<p>DISABLE ENABLE</p>	Hot Start
SEG1RAMP or SEG1RATE	<p>0-99 hours.0-59 minutes Engineering units/minute or Engineering units/hour</p>	<p>Segment #1 Ramp Time or Segment #1 Ramp Rate</p> <p>Select TIME, EU/MIN, or EU/HR at prompt RAMPUNIT. All ramps will use the same selection.</p>

Configuration

Function Prompt Lower Display	Selections or Range of Setting Upper Display	Parameter Definition
SEG2 SP	Within the Setpoint limits	Segment #2 Soak Setpoint Value
SEG2TIME	0-99 hours.0-59 minutes	Segment #2 Soak Duration
SEG3RAMP or SEG3RATE SEG4 SP SEG4TIME SEG5RAMP or SEG5RATE SEG6 SP SEG6TIME SEG7RAMP or SEG7RATE SEG8 SP SEG8TIME SEG9RAMP or SEG9RATE SG10 SP SG10TIME SG11RAMP or SG11RATE SG12 SP SG12TIME	Selections are same as above.	Same as above

3.6 Accutune Set Up Group

Introduction

Accutune III automatically calculates GAIN, RATE, and RESET TIME (PID) tuning constants for your control loop. When initiated on demand, the Accutune algorithm measures a process step response and automatically generates the PID tuning constants needed for no overshoot on your process.

Fuzzy, Fuzzy Overshoot Suppression: When enabled, this configuration will suppress or eliminate any overshoot that may occur as a result of the existing tuning parameters, as the PV approaches the setpoint.

Tune, Demand Tuning: The tuning process is initiated through the operator interface keys or via a digital input (if configured). The algorithm then calculates new tuning parameters and enters them in the tuning group. *Tune* will operate with PIDA, PIDB, PD+MR and Three Position Step Control algorithms.

SP, SP Tuning: SP tuning continuously adjusts the PID parameters in response to setpoint changes. You can select tuning on minimum setpoint changes of 5 % up to 15 % span. Perform SP tuning after you have configured the controller. SP Tuning does not operate with the Three Position Step Control algorithm.

Simplex Tuning is used when a Simplex Control Algorithm is configured and uses the current SP value and alters the output over the Output Limit Range.

Duplex Tuning is used when a Duplex Control Algorithm is configured. To perform a Duplex Tune, Two Local Setpoints must be configured per the Control Group in Section 3.11.

Function Prompts

Table 3-6 ACCUTUNE Group Function Prompts

Function Prompt Lower Display	Selections or Range of Setting Upper Display	Parameter Definition
FUZZY	DISABLE ENABLE	<p>FUZZY OVERSHOOT SUPPRESSION—Can be enabled or disabled independently of whether Demand Tuning or SP Tuning is enabled or disabled.</p> <p>DISABLE—Disables Fuzzy Overshoot Suppression.</p> <p>ENABLE—The instrument uses Fuzzy Logic to suppress or minimize any overshoot that may occur when PV approaches SP. It will not recalculate any new tuning parameters.</p>

Function Prompt Lower Display	Selections or Range of Setting Upper Display	Parameter Definition
ACCUTUNE	DISABLE TUNE	<p>ACCUTUNE III</p> <p>DISABLE —Disables the Accutune function.</p> <p>DEMAND TUNING—If TUNE is selected, and tuning is initiated through the operator interface or digital input (if configured), the algorithm calculates new tuning parameters and enters them into the tuning group. This tuning requires no process knowledge and does not require line out for initialization.</p>
<p>DUPLEX</p> <p><i>This prompt only appears when a Duplex Control Algorithm has been configured</i></p>	MANUAL AUTO DISABLE	<p>DUPLEX ACCUTUNING III – These prompts only appear when a duplex output type has been configured.</p> <p>MANUAL – Tune manually using LSP 1 and LSP 2 values. LSP 1 is used to derive tuning parameters associated with HEAT (output > 50 %). LSP 2 is used to derive tuning parameters associated with COOL (output < 50 %).</p> <p>AUTOMATIC – Tuning is performed automatically on both HEAT and COOL sequentially. LSP 1 is used for HEAT tuning and LSP 2 is used for COOL tuning. To initiate tuning, either LSP 1 or LSP 2 must be in use.</p> <p>DISABLE – The current SetPoint is used to derive a single set of blended tuning parameters. This tuning is performed over the range of the output limits similar to Simplex Tuning. The Tuning Parameters derived are placed into both the HEAT and COOL tune sets (PID 1 and PID 2).</p>
AT ERROR (Read Only)	NONE RUNNING ABORT SP2	<p>ACCUTUNE ERROR STATUS—When an error is detected in the Accutune process, an error prompt will appear.</p> <p>NONE—No errors occurred during last Accutune procedure.</p> <p>RUNNING—An Accutune process is still active checking process gain, even though “T” is not lit. It does not affect keyboard operation.</p> <p>CURRENT ACCUTUNE PROCESS ABORTED—Caused by one of the following conditions:</p> <ul style="list-style-type: none"> • changing to manual mode • digital input detected • in heat region of output but a cool output was calculated, or vice versa. <p>SP2—LSP2 not configured or a Setpoint other than LSP1 or LSP2 is in use.</p>

3.7 Algorithm Set Up Group

Introduction

This data deals with various algorithms in the controller and Timer functions.

The Timer section allows you to configure a time-out period and to select the timer start by either the keyboard (**RUN/HOLD** key) or Alarm 2. An optional digital input can also be configured to the start the timer. The timer display is selectable as either “time remaining” (*see TI REM*) or “elapsed time” (*see E TIME*).

Alarm 1 is activated at the end of the time-out period. When the timer is enabled, it has exclusive control of the alarm 1 relay—any previous alarm 1 configuration is ignored. At time-out, the timer is ready to be activated again by whatever action has been configured.

Function Prompts

Table 3-7 ALGORITHM Group Function Prompts

Function Prompt Lower Display	Selections or Range of Setting Upper Display	Parameter Definition
<p>CONT ALG</p>	<p>ON-OFF</p>	<p>The CONTROL ALGORITHM lets you select the type of control that is best for your process.</p> <p>ON/OFF is the simplest control type. The output can be either ON (100 %) or OFF (0 %). The Process Variable (PV) is compared with the setpoint (SP) to determine the sign of the error ($ERROR = PV - SP$). The ON/OFF algorithm operates on the sign of the error signal.</p> <p>In Direct Acting Control, when the error signal is positive, the output is 100 %; and when the error signal is negative, the output is 0 %. If the control action is reverse, the opposite is true. An adjustable overlap (Hysteresis Band) is provided between the on and off states.</p> <p>ATTENTION <i>Other prompts affected: OUT HYST</i></p> <p>DUPLEX ON/OFF is an extension of this algorithm when the output is configured for a Duplex control algorithm. It allows the operation of a second ON/OFF output. There is a deadband between the operating ranges of the two inputs and an adjustable overlap (hysteresis) of the on and off states of each output. Both Deadband and Hysteresis are separately adjustable. With no relay action the controller will read 50 %.</p> <p>ATTENTION <i>Other prompts affected: OUT HYST and DEADBAND</i></p>

Function Prompt Lower Display	Selections or Range of Setting Upper Display	Parameter Definition
	<p>PID A</p> <p>ATTENTION PID A should not be used for Proportional only action; i.e., no integral (reset) action. Instead, use PD+MR with rate set to 0.</p> <p>PID B</p> <p>PD+MR</p>	<p>PID A is normally used for three-mode control. This means that the output can be adjusted somewhere between 100 % and 0 %. It applies all three control actions—Proportional (P), Integral (I), and Derivative (D)—to the error signal.</p> <p>Proportional (Gain)—Regulates the controller’s output in proportion to the error signal (the difference between Process Variable and Setpoint).</p> <p>Integral (Reset)—Regulates the controller’s output to the size of the error and the time the error has existed. (The amount of corrective action depends on the value of proportional Gain.)</p> <p>Derivative (Rate)—Regulates the controller’s output in proportion to the rate of change of the error. (The amount of corrective action depends on the value of proportional Gain.)</p> <p>PID B—Unlike the PID A equation, the controller gives only an integral response to a setpoint change, with no effect on the output due to the gain or rate action, and it gives full response to PV changes. Otherwise controller action is as described for the PID A equation. See note on PID A.</p> <p>PD WITH MANUAL RESET is used whenever integral action is not wanted for automatic control. The equation is computed with no integral contribution. The MANUAL RESET, which is operator adjustable, is then added to the present output to form the controller output.</p> <p>Switching between manual and automatic mode will be bumpless.</p> <p>If you select PD with Manual Reset you can also configure the following variations:</p> <ul style="list-style-type: none"> • PD (Two Mode) control, • P (Single Mode) control. <p>Set Rate (D) to 0.</p> <p>ATTENTION Other prompts affected: MAN RSET in the Tuning Set Up group</p>

Function Prompt Lower Display	Selections or Range of Setting Upper Display	Parameter Definition
CONT ALG (continued)	3PSTEP	<p>THREE POSITION STEP—The Three Position Step Control algorithm allows the control of a valve (or other actuator) with an electric motor driven by two controller relay outputs; one to move the motor upscale, the other downscale without a feedback slidewire linked to the motor shaft. The deadband is adjustable in the same manner as the duplex output algorithm.</p> <p>The Three Position Step Control algorithm provides an output display (OUT) which is an estimated motor position, since the motor is not using any slidewire feedback. Although this output indication is only an approximation, it is “corrected” each time the controller drives the motor to one of its stops (0 % or 100 %). It avoids all the control problems associated with the feedback slidewire (wear, dirt, noise). When operating in this algorithm, the estimated OUT display is shown to the nearest percent (i.e., no decimal). This selection forces the Output Algorithm selection to “POSITON”. See <i>Subsection 3.8</i>.</p> <p>Refer to the <i>Operation</i> section for motor position displays.</p> <p>As a customer configurable option, when a second input board is installed, the motor slidewire can be connected to the controller. The actual slidewire position is then shown on the lower display as POS. This value is used for display only. It is NOT used in the Three Position Step algorithm. To configure this option, set Input 2 actuation to SLIDEW and then calibrate Input 2 per <i>Subsection 6.4</i>.</p> <p>ATTENTION Other prompts affected: DEADBAND</p>
TIMER	DISABLE ENABLE	<p>TIMER allows you to enable or disable the timer option.</p> <p>The timer option allows you to configure a timeout period and to select timer start by either the keyboard (RUN/HOLD key) or Alarm 2. A digital input can also be configured to start the timer.</p> <p>When the timer is enabled, it has exclusive control of the alarm 1 relay; any previous alarm configuration is ignored. At timeout, the timer is ready to be re-activated by whatever action has been configured. Alarm 1 is activated at the end of the timeout period.</p>
PERIOD	0:00 to 99:59	PERIOD allows you to configure the length of timeout period (from 0 to 99 hours: 59 minutes).

Function Prompt Lower Display	Selections or Range of Setting Upper Display	Parameter Definition
START	KEY ALARM 2	START allows you to select whether the timer starts with the keyboard (Run/Hold key) or Alarm 2.
LOW DISP	TI REM E TIME	<p>LOW DISP allows you to select whether time remaining (TI REM) or elapsed time (E TIME) is displayed for the timer option.</p> <p>The time is shown on the lower display in HH:MM format along with a rotating “clock” character.</p> <ul style="list-style-type: none"> • If the “clock” rotation is <i>clockwise</i>, elapsed time is indicated. • If the “clock” rotation is <i>counterclockwise</i>, time remaining is indicated.
RESET	KEY ALARM 1	RESET allows you to reset the timer with the keyboard (Run/Hold key) or Alarm 1.
INCREMENT	MINUTES SECONDS	INCREMENT allows you to increment the timer in either minutes or seconds.

INPUT MATH ALGORITHMS—Controllers with two inputs are provided with one input algorithm. Unless otherwise noted, these selections are provided only as part of the Math Options package. Each algorithm can be configured to provide a derived (calculated) PV or a derived Remote Setpoint. Up to three inputs may be applied to the calculation. See Inputs A, B, and C for definitions per equation.

All algorithms operate in engineering units except Feedforward (F FWRD) which operates in percent of output units.

ATTENTION When the Input C configuration is set to NONE, the value of Input C used in the functions is automatically set to 1.0, except for the Summer algorithm, where it is set to 0.0.

INP ALG1	NONE	<p>INPUT ALGORITHM 1 has the following selections from which to choose:</p> <p>NONE—No algorithm configured</p>
	<p>W AVG (See Note 2)</p> <p>(Standard feature on controllers with two analog inputs)</p> $\text{Alg1} = [(\text{Input A} \times \text{Ratio A} + \text{Bias A}) + (\text{K} \times \text{Input B} \times \text{Ratio B} + \text{Bias B})] / (1 + \text{K}) + \text{Alg1Bias}$	<p>WEIGHTED AVERAGE—When you configure for Weighted Average, the controller will compute a PV or SP for the control algorithm from the following equation:</p>
	<p>F FWRD</p> <p>(Standard feature on controllers with two analog inputs)</p>	<p>FEEDFORWARD SUMMER—Feedforward uses Input A, following a Ratio and Bias calculation as a value summed directly with the PID computed output value and sent, as an output value, to the final control element.</p> <p>This algorithm will only function in automatic mode and is not used for Three Position Step Control applications.</p> <p>The following formula applies:</p>

Function Prompt Lower Display	Selections or Range of Setting Upper Display	Parameter Definition
		$\text{Controller Output} = \text{PID Output} + (\text{Input A} \times \text{Ratio A} + \text{Bias A}) \times (100 / \text{Input A Range})$
	FFWDMu (Standard feature on controllers with two analog inputs)	<p>FEEDFORWARD MULTIPLIER—Feedforward uses Input A, following a Ratio and Bias calculation as a value multiplied directly with the PID computed output value and sent, as an output value, to the final control element.</p> <p>This algorithm will only function in automatic mode and cannot be used for Three Position Step Control applications.</p> <p>The following formula applies:</p> $\text{Controller Output} = \text{PID Output} \times (\text{Input A} \times \text{Ratio A} + \text{Bias A}) / \text{Input A Range}$
	SUMMER (See Note 2)	<p>SUMMER WITH RATIO AND BIAS—The following formula applies:</p> $\text{Alg1} = (\text{Input A} \times \text{Ratio A} + \text{Bias A}) + (\text{Input B} \times \text{Ratio B} + \text{Bias B}) + (\text{Input C} \times \text{Ratio C} + \text{Bias C}) + \text{Alg1Bias}$
	HI SEL (See Note 2)	<p>INPUT HIGH SELECT WITH RATIO AND BIAS—This selection specifies the PV or SP as the higher of Input 1 or Input 2. The following formula applies:</p> $\text{Alg1} = \text{higher of } (\text{Input A} \times \text{Ratio A} + \text{Bias A}) \text{ or } (\text{Input B} \times \text{Ratio B} + \text{Bias B})$
	LO SEL (See Note 2)	<p>INPUT LOW SELECT WITH RATIO AND BIAS—This selection specifies the PV or SP as the lower of Input 1 or Input 2. The following formula applies:</p> $\text{Alg1} = \text{lower of } (\text{Input A} \times \text{Ratio A} + \text{Bias A}) \text{ or } (\text{Input B} \times \text{Ratio B} + \text{Bias B})$
	$\sqrt{\text{MuDIV}}$ (See Note 1)	<p>MULTIPLIER DIVIDER WITH SQUARE ROOT—The following formula applies:</p> $\text{Alg1} = K \times \text{Sq.Rt.} \{ (\text{Input A} \times \text{Ratio A} + \text{Bias A}) \times (\text{Input C} \times \text{Ratio C} + \text{Bias C}) / (\text{Input B} \times \text{Ratio B} + \text{Bias B}) \}$ $\times (\text{Calc Hi} - \text{Calc Lo}) + \text{Alg1Bias}$ <p>See Figure 3-1 at the end of this section for an example of Mass Flow Compensation using the Multiplier/Divider Algorithm.</p>
	$\sqrt{\text{MULT}}$ (See Note 1)	<p>MULTIPLIER WITH SQUARE ROOT—The following formula applies:</p> $\text{Alg1} = K \times \text{Sq.Rt.} \{ (\text{Input A} \times \text{Ratio A} + \text{Bias A}) \times (\text{Input B} \times \text{Ratio B} + \text{Bias B}) \times (\text{Input C} \times \text{Ratio C} + \text{Bias C}) \}$ $\times (\text{Calc Hi} - \text{Calc Lo}) + \text{Alg1Bias}$
	MuDIV (See Note 1)	<p>MULTIPLIER DIVIDER—The following formula applies:</p>

Function Prompt Lower Display	Selections or Range of Setting Upper Display	Parameter Definition
Alg1 = K x [((Input A x Ratio A + Bias A) x (Input C x Ratio C + Bias C)) / (Input B x Ratio B + Bias B)] x (Calc Hi – Calc Lo) + Alg1Bias	MULT (See Note 1)	MULTIPLIER —The following formula applies: Alg1 = K x [(Input A x Ratio A + Bias A) x (Input C x Ratio C + Bias C) x (Input B x Ratio B + Bias B)] x (Calc Hi – Calc Lo) + Alg1Bias
	<p>CARB A</p> <p>CARB B</p> <p>CARB C</p> <p>CARB D</p> <p>FCC</p> <p>DEW PT</p> <p>OXYGEN</p>	<p>CARBON POTENTIAL A—Make this selection if you have a Cambridge or Marathon monitor type Zirconium Oxide sensor. See Note 3.</p> <p>CARBON POTENTIAL B—Make this selection if you have a Corning type Zirconium Oxide sensor. This algorithm requires a temperature range within the region of 1380 to 2000°F. See Note 3.</p> <p>CARBON POTENTIAL C—Make this selection if you have an A.A.C.C. type Zirconium Oxide sensor. This algorithm requires a temperature range within the region of 1380 °F to 2000 °F. See Note 3.</p> <p>CARBON POTENTIAL D—Make this selection if you have a Barber Coleman, MacDhui, or Bricesco type Zirconium Oxide sensor. This algorithm requires a temperature range within the region of 1380 to 2000°F. See Note 3.</p> <p>CARBON POTENTIAL FCC—Make this selection if you have a Furnace Controls Corp Accucarb type Zirconium Oxide sensor. This algorithm requires a temperature range within the region of 1380 °F to 2000 °F. See Note 3.</p> <p>DEWPOINT OF CARBONIZING ATMOSPHERE—Use this selection if you are using any Zirconium Oxide Carbon Probe and you want to measure the atmosphere in terms of Dewpoint. The range is –50 °F to 100 °F or –48 °C to 38 °C. This algorithm requires a temperature range within the region of 1000 °F to 2200 °F and a minimum carbon probe value of 800 millivolts.</p> <p>PERCENT OXYGEN RANGE—Make this selection if you are using a Zirconium Oxide Oxygen Probe to measure Percent of Oxygen in a range of 0 to 40 % O₂. This algorithm requires a temperature range within the region of 800 °F to 3000 °F.</p>

Function Prompt Lower Display	Selections or Range of Setting Upper Display	Parameter Definition
<p>ATTENTION The Carbon and Dewpoint selections will automatically set the first input actuation to Carbon. The Oxygen selection will automatically set the first input actuation to Oxygen. Input 2 can be any input actuation, but it is normally a type K, R or S thermocouple input, depending upon the probe type selected. All calculations are performed by the Controller with Percent Carbon shown as the PV display. The actual value of each analog input may be viewed on the lower display. For all Carbon Types, if the value of Percent Carbon falls below 0.1% - such as can happen when the Carbon Probe voltage output falls below 900 mVdc – then the Controller will continue to update the PV display, but the accuracy is unspecified. Likewise, if the measured temperature falls outside of the specified ranges as noted above for the Carbon, Oxygen and Dewpoint input types, then the Controller will continue to update the PV display, but the accuracy is unspecified. For the Dewpoint algorithm, if the Carbon Sensor voltage falls below 800 mVdc, then the Dew Point is calculated as if the sensor voltage was at 800 mVdc.</p>		
MATH K	0.001 to 1000 floating	WEIGHTED AVERAGE RATIO OR MASS FLOW ORIFICE CONSTANT (K) FOR MATH SELECTIONS —Only applicable for algorithms W AVG or General Math selections $\sqrt{\text{MuDIV}}$, $\sqrt{\text{MULT}}$, MuDIV, or MULT.
CALC HI	–999. To 9999. Floating (in engineering units)	CALCULATED VARIABLE HIGH SCALING FACTOR FOR INPUT ALGORITHM 1 —Used only when either Summer, Input Hi/Lo, or one of the General Math functions was selected as the Input Algorithm. See Note 2.
CALC LO	–999. To 9999. Floating (in engineering units)	CALCULATED VARIABLE LOW SCALING FACTOR FOR INPUT ALGORITHM 1 —Used only when either Summer, Input Hi/Lo, or one of the General Math functions was selected as the Input Algorithm. See Note 2.
ALG1 INA	INPUT 1 INPUT 2 OUTPUT	ALGORITHM 1, INPUT A SELECTION will represent one of the available selections. Input 1 Input 2 Output – Should not be used for Three Position Step Control applications)
ALG1 INB	INPUT 1 INPUT 2 OUTPUT	ALGORITHM 1, INPUT B SELECTION will represent one of the available selections. Input 1 Input 2 Output – Should not be used for Three Position Step Control applications)
ALG1 INC	NONE INPUT 1 INPUT 2 OUTPUT	ALGORITHM 1, INPUT C SELECTION will represent one of the available selections. None Input 1 Input 2 Output – Should not be used for Three Position Step Control applications)

Function Prompt Lower Display	Selections or Range of Setting Upper Display	Parameter Definition
PCT CO	0.020 to 0.350 (fractional percent of CO)	<p>PERCENT CARBON is only applicable when Carbon Potential is selected. Enter the value in percent carbon monoxide that is applicable for the enriching gas used in fractional form.</p> <p>FOR EXAMPLE: Natural Gas = 20.0 % CO, then setting is 0.200 Propane Gas = 23.0 % CO, setting is 0.230</p>
ALG1 BIAS	-999 to 9999 floating (in engineering units)	INPUT ALGORITHM 1 BIAS —Does not apply to selections: FFWRD, FFWDMU, HISEL or LOSEL.
PCT H2	1.0 to 99.0 (% H ₂)	HYDROGEN CONTENT FOR DEWPOINT is only applicable when Dewpoint is selected. Enter a value for the percentage of Hydrogen content that is applicable.
<p>Math Algorithm Notes:</p> <ol style="list-style-type: none"> 1. Calculation ranges for the Math Algorithms are set via CALC HI and CALC LO parameters and are between -999. and 9999. The SP High and Low values (SP Range) are independent of these settings and can be any value between -999. and 9999. 2. The CALC HI and CALC LO values determine the range limits for the SP High and Low values for the Weighted Average, Summer, Hi Select and Low Select algorithms. 3. If the Ratio for Input 2 is set to 0.0, then a constant value may be used for the Input 2 value via the Input 2 Bias setting. For this configuration, the Input 2 low range and the Sooting diagnostic messages are disabled. 		

Figure 3-1 Mass Flow Example

Example - Mass Flow Compensation

A gas flow rate of 650 SCFM develops a differential pressure of 90" H₂O across an orifice plate at reference conditions of 30 psig and 140°F. Compensate this gas flow for temperature and pressure variations.

$$\text{Flow} = K \sqrt{\frac{DP_f \times P_f}{T_f} \times \frac{T_{ref}}{P_{ref}}}$$

Where:
 f = flowing conditions
 ref = reference conditions (in absolute units)

Apply Multiplier/Divider Algorithm:

$$PV = K \sqrt{\frac{(\text{Input A} \times \text{Ratio A} + \text{Bias A}) \times (\text{Input C} \times \text{Ratio C} + \text{Bias C})}{(\text{Input B} \times \text{Ratio B} + \text{Bias B})}} \times (\text{Calc HI} - \text{Calc LO})$$

Assign inputs using Engineering units:

Let:

- Input A = DP_f = IN1 (in H₂O)
- Input B = T_f = IN2 + Bias2 = IN2°F + 460 (°R)
- Input C = P_f = IN3 + Bias3 = IN3psig + 14.7(psia)
- T_{ref} = 140°F + 460 = 600°R
- P_{ref} = 30 psig + 14.7 = 44.7 psia

Calc_{Hi} = 650.0
 Calc_{Lo} = 0.0 > Flow in SFCM at Reference Conditions

K = to be determined next

Note: If temperature and pressure signals are already ranged in absolute units, no Bias is required for inputs B and C.

$$PV = Q_{SCFM} = \sqrt{\frac{DP_f \times (IN3 + 14.7)}{(IN2 + 460)}} \times K^2 \times (650.0 - 0.0)$$

Note: When IN2 and IN3 are at the reference conditions of 600°R (140°F) and 44.7psia (30 psig) respectively and DP_f = 90" H₂O, the equation must calculate 650 SCFM. To accomplish this, divide the DP value by "90" to normalize the equation.

$$Q_{SCFM} = \sqrt{\frac{DP_f}{90} \times \frac{(IN3 + 14.7)}{(IN2 + 460)}} \times \frac{T_{ref}}{P_{ref}} \times 650$$

Rearranging terms:

$$Q_{SCFM} = \sqrt{\frac{DP_f \times (IN3 + 14.7)}{(IN2 + 460)}} \times \frac{1}{90} \times \frac{T_{ref}}{P_{ref}} \times 650$$

↓ Variable ↓ Constant = K²

Example continued on next page

22049

Example - Mass Flow Compensation - continued

Determined value of K:

$$K^2 = \frac{1}{90} \times \frac{T_{ref}}{P_{ref}} = \frac{600}{(90)(44.7)} = 0.14914$$

Therefore K = 0.386

$$Q_{SCFM} = (0.386) (650) \sqrt{\frac{DP_f \text{ (in H}_2\text{O)} \text{ (IN3 + 14.7)}}{(IN2 + 460)}}$$

K (Calc_{HI} - Calc_{LO})

Summary of Flow Values At Values Conditions

	Temp (T _f) (°R)	Pressure (T _f) (psia)	Flow (SFCM)	
			DP _f = 45" H ₂ O (50%)	DP _f = 90" H ₂ O (100%)
Reference Conditions	140°F + 460	30 psi + 14.7	459	650
	170°F + 460	50 psi + 14.7	539	763
	170°F + 460	20 psi + 14.7	395	559
	110°F + 460	50 psi + 14.7	567	802
	110°F + 460	20 psi + 14.7	415	587

22050

3.8 Output Set Up Group

Introduction

This group deals with various output types in the controller, the Digital Output Status and the Current Output operation.

ATTENTION The Tuning Group is automatically configured to have two PID sets when a Duplex Control Algorithm is selected.

Function Prompts

Table 3-8 OUTPUT Group Function Prompts

Function Prompt Lower Display	Selections or Range of Setting Upper Display	Parameter Definition
OUT ALG		<p>The OUTPUT ALGORITHM lets you select the type of output you want. Not applicable with Control algorithm prompt 3PSTEP.</p> <p>Selections are hardware dependent. For example, if the controller does not have a current output, then none of the prompts for Output Algorithms that need a current output will appear. Likewise, if the controller does not have a relay output, then none of the prompts that need a relay output will appear.</p> <p>ATTENTION For all Duplex Output forms, PID heat parameters apply for controller output greater than 50 %; PID cool parameters apply for controller output less than 50 %.</p>
	TIME	<p>TIME SIMPLEX—This output algorithm uses Digital Output 1 for Time Proportional Control. The output is updated per the Loop sampling rate selection. Time Proportional Output has a resolution of 4.44 msec. Cycle Time is adjustable from 1 to 120 seconds.</p>
	CURRENT	<p>CURRENT SIMPLEX—Type of output using one 4 mA to 20 mA signal that can be fed into a positive or negative grounded load of 0 to 1000 ohms. This signal can easily be configured for 4-20 mA or 0-20 mA operation via the CO RANGE configuration, below.</p>
	POSITON	<p>POSITION PROPORTIONAL —Type of output using two relays and a motor that has a 100 to 1000 ohms feedback slidewire.</p> <p>This output algorithm selection forces Input 2 to the SLIDEW selection when the Control Algorithm is any selection other than 3PSTEP.</p> <p>ATTENTION <i>Other prompts affected: DEADBAND, IN2 TYPE</i></p>

Function Prompt Lower Display	Selections or Range of Setting Upper Display	Parameter Definition
	TIME D	<p>TIME DUPLEX—This output algorithm uses Digital Outputs 1 and 2 for Duplex Time Proportional Control. The outputs are updated per the Loop sampling rate selection. Time Proportional Output has a resolution of 4.44 msec. Cycle Time is adjustable from 1 second to 120 seconds.</p>
	CUR D	<p>CURRENT DUPLEX is similar to current simplex but uses a second current output. The second output is usually scaled so that zero and span correspond with 0 % and 50 % output (cool zone). When the output is 0 % to 50 %, the controller uses tuning parameter set #2, when the output is 50 % to 100 % it uses set #1.</p> <p>ATTENTION <i>Other prompts affected: OUT RNG</i></p>
	CUR TI	<p>CURRENT/TIME DUPLEX is a variation of duplex with current active for 0 % to 50 % output (tuning set 2) and time is active 50 % to 100 % output (tuning set 1). Relay controls heat, current controls cool.</p> <p>ATTENTION <i>Other prompts affected: OUT RNG</i></p>
	TI CUR	<p>TIME CURRENT DUPLEX is similar to CUR TI except that current is active for 50 % to 100 % and time is active for 0 % to 50 %. Relay controls cool, current controls heat.</p> <p>ATTENTION <i>Other prompts affected: OUT RNG</i></p>
OUT RNG	50 PCT	<p>CURRENT DUPLEX RANGE ALGORITHM — Used with Output Algorithm selections CUR D, CUR TI, or TI CUR.</p> <p>CURRENT DUPLEX RANGE (SPLIT)—This setting should be used for Relay/Current and Current/Relay Duplex Outputs. It can also be used for Current Duplex when an Auxiliary Output board is present. This enables the normal control current output to provide heat control and the auxiliary current output to provide cool control. To enable this:</p> <ul style="list-style-type: none"> • AUX OUT in the Options Set Up group must be selected for Output. • The Auxiliary Current Output is scaled as desired for 0-50 % controller output. • Deadband for this configuration only applies to the Current Output. The Auxiliary Output must have the Deadband scaled in. <p>FOR EXAMPLE:</p>

Function Prompt Lower Display	Selections or Range of Setting Upper Display	Parameter Definition								
	100PCT	<p>If a 2 % Deadband is desired, then enter 2.0 for the Deadband selection in the Control Algorithm group. This will apply Deadband to the Current Output. In the Options group, set the Auxiliary Output LOW VAL selection to 49.0 and the HIGH VAL selection to 0.0.</p> <p>CURRENT DUPLEX RANGE (FULL) enables the Current Output to provide both heat and cool functions for control over 0-100 % of the controller output. The PID heat parameters apply when the output is greater than 50 % and the PID cool parameters apply when the output is less than 50 %. The second current output is not required for this type of duplex operation.</p>								
RLYSTATE	1OF 2OF 1ON 2OF 1OF 2ON 1ON 2ON	<p>DIGITAL OUTPUT STATUS AT 0 % OUTPUT allows the following selections:</p> <table border="0"> <tr> <td data-bbox="818 856 938 884">1OF 2OF</td> <td data-bbox="1008 856 1279 919">Output 1 de-energized Output 2 de-energized</td> </tr> <tr> <td data-bbox="818 932 938 959">1ON 2OF</td> <td data-bbox="1008 932 1279 995">Output 1 energized Output 2 de-energized</td> </tr> <tr> <td data-bbox="818 1008 938 1035">1OF 2ON</td> <td data-bbox="1008 1008 1279 1071">Output 1 de-energized Output 2 energized</td> </tr> <tr> <td data-bbox="818 1083 938 1110">1ON 2ON</td> <td data-bbox="1008 1083 1279 1146">Output 1 energized Output 2 energized</td> </tr> </table>	1OF 2OF	Output 1 de-energized Output 2 de-energized	1ON 2OF	Output 1 energized Output 2 de-energized	1OF 2ON	Output 1 de-energized Output 2 energized	1ON 2ON	Output 1 energized Output 2 energized
1OF 2OF	Output 1 de-energized Output 2 de-energized									
1ON 2OF	Output 1 energized Output 2 de-energized									
1OF 2ON	Output 1 de-energized Output 2 energized									
1ON 2ON	Output 1 energized Output 2 energized									
RLY TYPE	MECHAN SOL ST	<p>RELAY CYCLE TIME INCREMENT selection is used only for Time Simplex and Duplex output configurations. This configuration sets the increment size of the relay cycle times in the Tuning and Tuning 2 Set Up groups.</p> <p>ELECTROMECHANICAL RELAY—Cycle time in one-second increments.</p> <p>SOLID STATE RELAY—Cycle time in 1/3 second increments. This is useful for solid state relay applications that require shorter cycle times. DO NOT use this setting unless cycle times of less than 1 second are required.</p> <p>ATTENTION The Lockout selection must be set to NONE in order to view this selection.</p>								
MOTOR TI	5 to 1800 seconds	<p>MOTOR TIME – Appears only when “POSITON” is selected as the Output algorithm. This is the time it takes the motor to travel from 0 to 100% (fully closed to fully open). This time can usually be found on the nameplate of the motor.</p>								

Function Prompt Lower Display	Selections or Range of Setting Upper Display	Parameter Definition
CUR OUT	DISABLE INPUT 1 INPUT 2 PV DEV OUTPUT SP LSP RSP IN ALG 1	<p>CURRENT OUTPUT – If Current Output #1 is not used to perform one of the above output algorithms, it may be used to perform an Auxiliary Output function.</p> DISABLE INPUT 1 INPUT 2 PV (Process Variable) DEVIATION OUTPUT SETPOINT LOCAL SETPOINT REMOTE INPUT ALGORITHM 1
LOW VAL	Low Scale Value within the range of the selected variable to represent the minimum output (0 or 4 mA)	<p>CURRENT OUTPUT LOW SCALING FACTOR— Used only when CUR OUT is any selection other than DISABLE. This is a value in engineering units used to represent all CUR OUT parameters except Output.</p> <p>For Output, this is a value in percent and can be any value between –5 % and +105 %. However, keep in mind that relay output types can only be scaled 0 % to 100 %.</p>
HIGH VAL	High Scale Value within the range of the selected variable to represent the maximum output (20 mA)	<p>CURRENT OUTPUT HIGH SCALING FACTOR— Used only when CUR OUT is any selection other than DISABLE. This is a value in engineering units used to represent all CUR OUT parameters except Output.</p> <p>For Output, this is a value in percent and can be any value between –5 % and +105 %. However, keep in mind that relay output types can only be scaled 0 % to 100 %.</p>
CO RANGE	4-20mA 0-20mA	<p>CURRENT OUTPUT RANGE allows the user to easily select 4-20 mA output or 0-20 mA output operation without the need for recalibration of the instrument.</p> <p>ATTENTION Changing the Current Output Range will result in the loss of Field Calibration values and will restore Factory Calibration values.</p>

3.9 Input 1 Set Up Group

Introduction

This data deals with various parameters required to configure Input 1.

Function Prompts

Table 3-9 INPUT 1 Group Function Prompts

Function Prompt Lower Display	Selections or Range of Setting Upper Display	Parameter Definition
<p>IN1 TYPE</p> <p>ATTENTION Changing the input type will result in the loss of Field Calibration values and will restore Factory Calibration values.</p>	<p>DISABLE B TC E TC H E TC L J TC H J TC M J TC L K TC H K TC M K TC L NNM H NNM L NIC H NIC L R TC S TC T TC H T TC L W TC H W TC L 100 PT 100 LO 200 PT 500 PT RAD RH RAD RI 0-20mA 4-20mA 0-10mV 0-50mV 0-100mV 0-5 V 1-5 V 0-10 V TC DIFF CARBON OXYGEN</p>	<p>INPUT 1 ACTUATION TYPE – This selection determines what actuation you are going to use for Input 1.</p> <p>DISABLE—Disables Input. B TC—B Thermocouple E TC H—E Thermocouple High E TC L—E Thermocouple Low J TC H—J Thermocouple High J TC M—J Thermocouple Med J TC L—J Thermocouple Low K TC H—K Thermocouple High K TC M—K Thermocouple Med K TC L—K Thermocouple Low NNM H—Ni-Ni-Moly Thermocouple High NNM L—Ni-Ni-Moly Thermocouple Low NIC H—Nicrosil-Nisil Thermocouple High NIC L—Nicrosil-Nisil Thermocouple Low R TC—R Thermocouple S TC—S Thermocouple T TC H—T Thermocouple High T TC L—T Thermocouple Low W TC H—W5W26 Thermocouple High W TC L—W5W26 Thermocouple Low 100 PT—100 Ohm RTD High 100 LO—100 Ohm RTD Low 200 PT—200 Ohm RTD 500 PT—500 Ohm RTD RAD RH—Radiamatic RH RAD RI—Radiamatic RI 0-20mA—0 to 20 Milliamperes 4-20mA—4 to 20 Milliamperes 0-10mV—0 to 10 Millivolts 0-50mV—0 to 50 Millivolts 0-100mV—0 to 100 Millivolts 0-5 V—0 to 5 Volts 1-5 V—1 to 5 Volts 0-10 V—0 to 10 Volts TC DIFF—Thermocouple Differential Carbon—Carbon Probe Input Oxygen—Oxygen Probe Input</p>

Function Prompt Lower Display	Selections or Range of Setting Upper Display	Parameter Definition
XMITTER	B TC S TC E TC H T TC H E TC L T TC L J TC H W TC H J TC M W TC L J TC L 100 PT K TC H 100 LO K TC M 200 PT K TC L 500 PT NNM H RAD RH NNM L RAD RI NIC H LINEAR NIC L SQROOT R TC	<p>TRANSMITTER CHARACTERIZATION—This selection lets you instruct the controller to characterize a linear input to represent a non-linear one. If characterization is performed by the transmitter itself, then select LINEAR.</p> <p>ATTENTION Prompt only appears when a linear actuation is selected at prompt IN1 TYPE.</p> <p>FOR EXAMPLE: If input 1 is a 4 to 20 mA signal, but the signal represents a type K H thermocouple, then configure K TC H and the controller will characterize the 4 to 20 mA signal so that it is treated as a type K thermocouple input (high range).</p> <p>Parameter definitions are the same as in IN1 TYPE.</p>
IN1 HIGH	–999. To 9999. Floating (in engineering units)	<p>INPUT 1 HIGH RANGE VALUE in engineering units is displayed for all inputs but can only be configured for linear or square root transmitter characterization.</p> <p>Scale the #1 input signal to the display value you want for 100 %.</p> <p>EXAMPLE: Process Variable = Flow Range of Flow = 0 to 250 Liters/Minute Actuation (Input 1) = 4 to 20 mA Characterization (XMITTER) = LINEAR Set IN1 HI display value to 250 Set IN1 LO display value to 0 Then 20 mA = 250 Liters/Minute and 4 mA = 0 Liters/Minute</p> <p>ATTENTION The control setpoint will be limited by the range of units selected here.</p>
IN1 LOW	–999. To 9999. Floating (in engineering units)	<p>INPUT 1 LOW RANGE VALUE in engineering units is displayed for all inputs but can only be configured for linear or square root transmitter characterization. Scale the #1 input signal to the display value you want for 0 %. See example above.</p> <p>ATTENTION The control setpoint will be limited by the range of units selected here.</p>
RATIO 1	–20.00 to 20.00 Floats to 3 decimal places	RATIO ON INPUT 1 —Select the Ratio value you want on Input 1.
BIAS IN1	–999. to 9999. (in engineering units)	BIAS ON INPUT 1 — Bias is used to compensate the input for drift of an input value due to deterioration of a sensor, or some other cause. Select the bias value you want on Input 1.

Function Prompt Lower Display	Selections or Range of Setting Upper Display	Parameter Definition
FILTER 1	0 to 120 seconds No filter = 0	FILTER FOR INPUT 1 —A software digital filter is provided for Input 1 to smooth the input signal. You can configure the first order lag time constant from 1 to 120 seconds. If you do not want filtering, enter 0.
BURNOUT	<p>NONE</p> <p>UP</p> <p>DOWN</p> <p>NO FS</p>	<p>BURNOUT PROTECTION (SENSOR BREAK) provides most input types with upscale or downscale protection if the input fails.</p> <p>NO BURNOUT—Pre-configured Failsafe output (selected in the CONTROL Set up Group) applied if failed input is detected (does not apply for an input out of range). Diagnostic message IN1 FAIL is intermittently flashed on the lower display.</p> <p>UPSCALE BURNOUT will force the Input 1 signal to the full scale value when the sensor fails. Diagnostic message IN1 FAIL intermittently flashed on the lower display.</p> <p>The controller remains in Automatic control mode and adjusts the controller output signal in response to the full scale Input 1 signal developed by the Burnout circuitry.</p> <p>DOWNSCALE BURNOUT will force the Input 1 signal to the lower range value when the sensor fails. Diagnostic message IN1 FAIL intermittently flashed on the lower display.</p> <p>The controller remains in Automatic control mode and adjusts the controller output signal in response to the lower range Input 1 signal developed by the Burnout circuitry.</p> <p>NO FAILSAFE— This selection does not provide input failure detection and should only be used when a thermocouple input is connected to another instrument which supplies the Burnout current. (For this selection, no burnout signal is sent to the sensor.)</p> <p>ATTENTION For Burnout to function properly on a 0-20 mA input type (or a 0-5V type that uses a dropping resistor), the dropping resistor must be remotely located (across the transmitter terminals). Otherwise, the input at the instrument terminals will always be 0 mA (i.e., within the normal operating range) when the 0-20 mA line is opened.</p>

Configuration

Function Prompt Lower Display	Selections or Range of Setting Upper Display	Parameter Definition
EMISSIV1	0.01 to 1.00	EMISSIVITY is a correction factor applied to the Radiamatic input signal that is the ratio of the actual energy emitted from the target to the energy which would be emitted if the target were a perfect radiator. Available only for Radiamatic inputs.

3.10 Input 2 Set Up Group

Introduction

This data deals with various parameters required to configure Input 2.

Function Prompts

Table 3-10 INPUT 2 Group Function Prompts

Function Prompt Lower Display	Selections or Range of Setting Upper Display	Parameter Definition
<p>IN2 TYPE</p> <p>ATTENTION Changing the input type will result in the loss of Field Calibration values and will restore Factory Calibration values.</p> <p>Selecting Position Proportional Control in the Output Setup Group forces Input 2 to the Slidewire Selection.</p>	<p>DISABLE B TC E TC H E TC L J TC H J TC M J TC L K TC H K TC M K TC L NNM H NNM L NIC H NIC L R TC S TC T TC H T TC L W TC H W TC L 100 PT 100 LO 200 PT 500 PT RAD RH RAD RI 0-20mA 4-20mA 0-10mV 0-50mV 0-100mV 0-5 V 1-5 V 0-10 V TC DIFF SLIDEW</p>	<p>INPUT 2 ACTUATION TYPE – This selection determines what actuation you are going to use for Input 2.</p> <p>DISABLE—Disables Input. B TC—B Thermocouple E TC H—E Thermocouple High E TC L—E Thermocouple Low J TC H—J Thermocouple High J TC M—J Thermocouple Med J TC L—J Thermocouple Low K TC H—K Thermocouple High K TC M—K Thermocouple Med K TC L—K Thermocouple Low NNM H—Ni-Ni-Moly Thermocouple High NNM L—Ni-Ni-Moly Thermocouple Low NIC H—Nicrosil-Nisil Thermocouple High NIC L—Nicrosil-Nisil Thermocouple Low R TC—R Thermocouple S TC—S Thermocouple T TC H—T Thermocouple High T TC L—T Thermocouple Low W TC H—W5W26 Thermocouple High W TC L—W5W26 Thermocouple Low 100 PT—100 Ohm RTD High 100 LO—100 Ohm RTD Low 200 PT—200 Ohm RTD 500 PT—500 Ohm RTD RAD RH—Radimatic RH RAD RI—Radimatic RI 0-20mA—0 to 20 Milliamperes 4-20mA—4 to 20 Milliamperes 0-10mV—0 to 10 Millivolts 0-50mV—0 to 50 Millivolts 0-100mV—0 to 100 Millivolts 0-5 V—0 to 5 Volts 1-5 V—1 to 5 Volts 0-10 V—0 to 10 Volts TC DIFF—Thermocouple Differential SLIDEW—Slidewire (For Position Proportional Applications)</p>

Function Prompt Lower Display	Selections or Range of Setting Upper Display	Parameter Definition
XMITTER2	B TC S TC E TC H T TC H E TC L T TC L J TC H W TC H J TC M W TC L J TC L 100 PT K TC H 100 LO K TC M 200 PT K TC L 500 PT NNM H RAD RH NNM L RAD RI NIC H LINEAR NIC L SQROOT R TC	<p>TRANSMITTER CHARACTERIZATION—This selection lets you instruct the controller to characterize a linear input to represent a non-linear one.</p> <p>ATTENTION Prompt only appears when a linear actuation is selected at prompt IN2 TYPE.</p> <p>FOR EXAMPLE: If input 2 is a 4 to 20 mA signal, but the signal represents a type K thermocouple, then select K TC H and the controller will characterize the 4 to 20 mA signal so that it is treated as a type K thermocouple input (high range).</p> <p>Parameter definitions are the same as in IN2 TYPE.</p>
IN2 HIGH	–999. To 9999. Floating (in engineering units)	<p>INPUT 2 HIGH RANGE VALUE in engineering units is displayed for all inputs but can only be configured for linear or square root transmitter characterization</p> <p>See the example in IN1 HI.</p>
IN2 LOW	–999. To 9999. Floating (in engineering units)	<p>INPUT 2 LOW RANGE VALUE in engineering units is displayed for all inputs but can only be configured for linear or square root transmitter characterization.</p> <p>See the example in IN1 HI</p>
RATIO 2	–20.00 to 20.00 Floats to 3 decimal places	RATIO ON INPUT 2 —Select the Ratio value you want on Input 1.
BIAS IN2	–999. to 9999. (in engineering units)	BIAS ON INPUT 2 — Bias is used to compensate the input for drift of an input value due to deterioration of a sensor, or some other cause. Select the bias value you want on Input 1.
FILTER 2	0 to 120 seconds No filter = 0	FILTER FOR INPUT 2 —A software digital filter is provided for Input 1 to smooth the input signal. You can configure the first order lag time constant from 1 to 120 seconds. If you do not want filtering, enter 0.
BURNOUT	NONE	<p>BURNOUT PROTECTION (SENSOR BREAK) provides most input types with upscale or downscale protection if the input fails.</p> <p>NO BURNOUT—If Input 2 is being used in the Control Algorithm (such as the PV or RSP input parameter), then the pre-configured Failsafe output (selected in the CONTROL Set up Group) is applied when a failed input is detected (does not apply for an input out of range). Diagnostic message IN2 FAIL is intermittently flashed on the lower display.</p>

3.11 Control Set Up Group



Introduction

The functions listed in this group deal with how the controller will control the process including: Number of Tuning Parameter Sets, Setpoint Source, Tracking, Power-up Recall, Setpoint Limits, Output Direction and Limits, Deadband, and Hysteresis.

Function Prompts

Table 3-11 CONTROL Group Function Prompts

Function Prompt Lower Display	Selections or Range of Setting Upper Display	Parameter Definition
PV SOURCE	INPUT 1 INPUT 2 IN ALG1	<p>PROCESS VARIABLE SOURCE —Selects the source of the Process Variable.</p> <p>INPUT 1 INPUT 2 INPUT ALGORITHM 1</p>
PID SETS	1 ONLY 2KEYBD	<p>NUMBER OF TUNING PARAMETER SETS—This selection lets you choose one or two sets of tuning constants (gain, rate, and reset). NOTE: The Tuning Group is automatically configured to have two PID sets when a Duplex Control Algorithm is configured.</p> <p>ONE SET ONLY—Only one set of tuning parameters is available. Configure the values for: Gain (proportional band), Rate, Reset Time, and Cycle Time (if time proportional is used).</p> <p>TWO SETS KEYBOARD SELECTABLE—Two sets of tuning parameters can be configured and can be selected at the operator interface or by using the Digital Inputs.</p> <div style="text-align: center;">  </div> <p>Press this key until you see PID SET1 or PID SET2 then press ▲ or ▼ to switch between sets. Configure the values for: Gain, Rate, Reset, Cycle Time Gain #2, Rate #2, Reset #2, Cycle #2 Time</p>

Function Prompt Lower Display	Selections or Range of Setting Upper Display	Parameter Definition
<p>PID SETS (continued)</p>	<p>2PV SW</p>	<p>TWO SETS PV AUTOMATIC SWITCHOVER— When the process variable is <i>GREATER</i> than the value set at prompt SW VALUE (Switchover Value), the controller will use Gain, Rate, Reset, and Cycle Time. The active PID SET can be read in the lower display.</p> <p>When the process variable is <i>LESS</i> than the value set at prompt SW VALUE, the controller will use Gain #2, Rate #2, Reset #2, and Cycle #2 Time. The active PID SET can be read in the lower display.</p> <p>ATTENTION <i>Other prompts affected: SW VALUE</i></p>
	<p>2SP SW</p>	<p>TWO SETS SP AUTOMATIC SWITCHOVER— When the setpoint is <i>GREATER</i> than the value set at prompt SW VALUE (Switchover Value), the controller will use Gain, Rate, Reset, and Cycle.</p> <p>When the setpoint is <i>LESS</i> than the value set at prompt SW VALUE, the controller will use Gain #2, Rate #2, Reset #2, and Cycle #2.</p> <p>ATTENTION <i>Other prompts affected: SW VALUE</i></p> <p>SW VALUE Value in engineering units within PV or SP range limits</p> <p>AUTOMATIC SWITCHOVER VALUE—This is the value of Process Variable or Setpoint at which the controller will switch from Tuning Constant Set #2 to Set #1.</p> <p>ATTENTION <i>Only appears when PID SETS selection is configured for either 2 PVSW or 2 SPSW.</i></p>
<p>LSP'S</p>	<p>1 ONLY</p> <p>TWO</p> <p>THREE</p>	<p>LOCAL SETPOINT SOURCE—This selection determines what your local setpoint source will be.</p> <p>LOCAL SETPOINT—The setpoint entered from the keyboard.</p> <p>TWO LOCAL SETPOINTS—This selection lets you switch between two local setpoints using the  key.</p> <p>THREE LOCAL SETPOINTS—This selection lets you switch between three local setpoints using the  key.</p>

Function Prompt Lower Display	Selections or Range of Setting Upper Display	Parameter Definition
RSP SRC	NONE INPUT 2 IN ALG1	<p>REMOTE SETPOINT SOURCE—This selection determines what your remote setpoint source will be when toggled by the SP Select key or Digital Input.</p> <p>NONE—No remote setpoint. INPUT 2—Remote Setpoint is Input 2. IN AL1—Remote Setpoint using Input 1 algorithm.</p> <p>ATTENTION To cycle through the available local setpoints and remote setpoint, press and hold in the  key. When the key is released, the setpoint selection currently displayed will be the new setpoint selection.</p>
AUTOBIAS	DISABLE ENABLE	<p>AUTOBIAS is used for bumpless transfer when transferring from local setpoint to remote setpoint. Auto Bias calculates and adds a bias to remote setpoint input each time a transfer is made.</p> <p>Only available if no tracking is selected.</p> <p>DISABLE—Disables auto bias. ENABLE—Enables auto bias.</p>
SP TRACK	NONE PV RSP	<p>SETPOINT TRACKING—The local setpoint can be configured to track either PV or RSP as listed below. Not configurable when Auto Bias is set.</p> <p>ATTENTION For selections other than NONE, LSP is stored in nonvolatile memory only when there is a mode change; i.e., when switching from RSP to LSP or from Manual to Automatic. If power is lost, then the current LSP value is also lost.</p> <p>NO TRACKING—If local setpoint tracking is not configured, the LSP will not be altered when transfer from RSP to LSP is made.</p> <p>PV—Local setpoint tracks the PV when in manual. RSP—Local setpoint tracks remote setpoint when in automatic. When the controller transfers out of remote setpoint, the last value of the remote setpoint (RSP) is inserted into the local setpoint.</p>
PWR MODE	MANUAL A LSP	<p>POWER UP CONTROLLER MODE RECALL—This selection determines which mode and setpoint the controller will use when the controller restarts after a power loss.</p> <p>MANUAL, LSP—At power-up, the controller will use manual mode with the local setpoint displayed. AUTOMATIC MODE, LAST LSP—At power-up, the controller will use automatic mode with the last local setpoint used before power down displayed.</p>

Function Prompt Lower Display	Selections or Range of Setting Upper Display	Parameter Definition
	A RSP AM SP AM LSP	AUTOMATIC MODE, LAST RSP —At power-up, the controller will use automatic mode with the last remote setpoint used before power down displayed. LAST MODE/LAST SETPOINT used before power down. LAST MODE/LAST LOCAL SETPOINT on power down.
PWR OUT For Three Position Step Control Only (Note 3)	LAST F'SAFE	THREE POSITION CONTROL STEP OUTPUT START-UP MODE —This selection determines what position the motor will be in when powered up or in the failsafe position. LAST OUTPUT —At power-up in automatic mode, the motor position will be the last one prior to power down. When the unit goes into FAILSAFE, it will stay in automatic mode; motor will not be driven to the configured failsafe position. FAILSAFE OUTPUT —At power-up in manual mode, the motor will be driven to either the 0 % or 100 % output position, whichever is selected at prompt FAILSAFE. For Burnout/None, when the unit goes into FAILSAFE, it will go to manual mode; motor will be driven to the configured failsafe position.
SP HiLIM (Note 4)	0 to 100 % of PV span in engineering units	SETPOINT HIGH LIMIT —This selection prevents the local and remote setpoints from going above the value selected here. The setting must be equal or less than the upper range of the PV.
SP LoLIM (Note 4)	0 to 100 % of PV span in engineering units	SET POINT LOW LIMIT —This selection prevents the local and remote setpoints from going below the value selected here. The setting must be equal or greater than the lower range of the PV.
ACTION	DIRECT REVERSE	CONTROL OUTPUT DIRECTION —Select direct or reverse output action. DIRECT ACTING CONTROL —The controller's output <i>increases</i> as the process variable increases. REVERSE ACTING CONTROL —The controller's output <i>decreases</i> as the process variable increases.
OUT RATE	ENABLE DISABLE	OUTPUT CHANGE RATE —Enables or disables the Output Change Rate. The maximum rate is set at prompt PCT/M UP or PCT/M DN. Only available for PID-A, PID-B, PD+MR control algorithms. ENABLE —Allows output rate. DISABLE —Disables output rate.

Function Prompt Lower Display	Selections or Range of Setting Upper Display	Parameter Definition
PCT/M UP	0 to 9999 % per minute	OUTPUT RATE UP VALUE —This selection limits the rate at which the output can change upward. Enter a value in percent per minute. Appears only if OUT RATE is enabled. “0” means no output rate applied.
PCT/M DN	0 to 9999 % per minute	OUTPUT RATE DOWN VALUE —This selection limits the rate at which the output can change downward. Enter a value in percent per minute. Appears only if OUT RATE is enabled. “0” means no output rate.
OUTHILIM	0 % to 100 % –5 % to 105 %	HIGH OUTPUT LIMIT —This is the highest value of output beyond which you do not want the controller automatic output to exceed. For relay output types. For current output types.
OUTLoLIM	0 % to 100 % –5 % to 105 %	LOW OUTPUT LIMIT —This is the lowest value of output below which you do not want the controller automatic output to exceed. For relay output types. For current output types.
I Hi LIM (Note 5)	Within the range of the output limits	HIGH RESET LIMIT —This is the highest value of output beyond which you do not want reset action to occur
I Lo LIM (Note 5)	Within the range of the output limits	LOW RESET LIMIT —This is the lowest value of output beyond which you do not want reset action to occur.
DROPOFF (Note 5)	–5 to 105 % of output	CONTROLLER DROPOFF VALUE —Output value below which the controller output will drop off to the low output limit value set in prompt OUTLoLIM.
DEADBAND	–5.0 to 25.0 % 0.0 to 25.0 % 0.5 to 5.0 %	DEADBAND is an adjustable gap between the operating ranges of output 1 and output 2 in which neither output operates (positive value) or both outputs operate (negative value). Time Duplex On-Off Duplex Position Proportional and Three Position Step
OUT HYST	0.0 to 100.0 % of PV span	HYSTERESIS (OUTPUT RELAY) is an adjustable overlap of the ON/OFF states of each control output. This is the difference between the value of the process variable at which the control outputs energize and the value at which they de-energize. Only applicable for ON/OFF control.

Function Prompt Lower Display	Selections or Range of Setting Upper Display	Parameter Definition
FAILMODE	NoLATCH LATCH	<p>FAILSAFE MODE</p> <p>NON LATCHING—Controller stays in last mode that was being used (automatic or manual); If unit was in Automatic mode, then the output goes to the failsafe value. (NOTE 1, NOTE 2)</p> <p>LATCHING—Controller goes to manual mode; If unit was in Automatic mode, then the output goes to the failsafe value. (NOTE 2)</p>
FAILSAFE	0 to 100 % 0 PCT 100 PCT	<p>FAILSAFE OUTPUT VALUE—The value used here will also be the output level when you have Communications SHED set to failsafe or when NO BURNOUT is configured and Input 1 fails.</p> <p>ATTENTION Applies for all output types <i>except</i> Three Position Step Control.</p> <p>THREE POSITION STEP FAILSAFE OUTPUT</p> <p>0 PCT—Motor goes to closed position.</p> <p>100 PCT—Motor goes to open position.</p>
SW FAIL	0 PCT 100 PCT	<p>Position Proportional motor position when slidewire fails.</p> <p>0 PCT—Motor goes to closed position.</p> <p>100 PCT—Motor goes to open position.</p> <p>ATTENTION PWR OUT must be configured for FSAFE.</p>
MAN OUT	0 to 100 %	<p>POWER-UP PRESET MANUAL OUTPUT—At power-up, the controller will go to manual and the output to the value set here. (NOTE 1)</p>
AUTO OUT	0 to 100 %	<p>POWER-UP PRESET AUTOMATIC OUTPUT—At power-up, the controller will begin its automatic control at the output value set here. (NOTE 1)</p>
PBorGAIN	PB PCT	<p>PROPORTIONAL BAND UNITS—Select one of the following for the Proportional (P) term of the PID algorithm:</p> <p>PROPORTIONAL BAND selects units of percent proportional band for the P term of the PID algorithm.</p> <p>Where: $PB \% = \frac{100 \% FS}{GAIN}$</p>

Function Prompt Lower Display	Selections or Range of Setting Upper Display	Parameter Definition
	GAIN	GAIN selects the unitless term of gain for the P term of the PID algorithm. <i>Where: GAIN = $\frac{100 \% FS}{PB\%}$</i>
MINUTESorRPM	 RPM MINUTES	RESET UNITS —Selects units of minutes per repeat or repeats per minute for the I term of the PID algorithm. 20 Repeats per Minute = 0.05 Minutes per Repeat. REPEATS PER MINUTE —The number of times per minute that the proportional action is repeated by reset. MINUTES PER REPEAT —The time between each repeat of the proportional action by reset.
<p>NOTE 1: Does not apply to Three Position Step Control.</p> <p>NOTE 2: If controller is in Manual mode when a failure occurs, then the output will maintain its value.</p> <p>NOTE 3: These selections appear when: A) Control Algorithm is selected for 3PSTEP. B) Control Algorithm is selected for PD+MR and Output Algorithm is selected for Position Proportional.</p> <p>NOTE 4: The local setpoint will automatically adjust itself to be within the setpoint limit range. For example, if SP = 1500 and the SP HiLIM is changed to 1200, the new local setpoint will be 1200.</p> <p>NOTE 5: Reset limits and Dropoff are not displayed when Three Position Step Control is configured.</p>		

3.12 Options Group

Introduction

The Options group lets you configure the remote mode switch (Digital Inputs) to a specific contact closure response, or configure the Auxiliary Output to be a specific selection with desired scaling.

Function Prompts

Table 3-12 OPTION Group Function Prompts

Function Prompt Lower Display	Selections or Range of Setting Upper Display	Parameter Definition
<p>AUX OUT</p> <p>ATTENTION Prompts for the Auxiliary Output Selection appear only if one of the Auxiliary Output boards is installed.</p>	<p>DISABLE</p> <p>INPUT 1</p> <p>INPUT 2</p> <p>PV</p>	<p>AUXILIARY OUTPUT SELECTION</p> <p>This selection provides an mA output representing one of several control parameters. The display for auxiliary output viewing will be in engineering units for all but output. Output will be displayed in percent.</p> <p>ATTENTION <i>Other prompts affected by these selections: 4mA VAL and 20mA VAL.</i></p> <p>ATTENTION Output cannot be configured when Three Position Step Control is used.</p> <p>NO AUXILIARY OUTPUT</p> <p>INPUT 1—This represents the configured range of input 1.</p> <p>FOR EXAMPLE: Type J Thermocouple (0 °F to 1600 °F) 0 °F display = 0 % output 1600 °F display = 100 % output</p> <p>INPUT 2 represents the value of the configured range of input 2.</p> <p>PROCESS VARIABLE—Represents the value of the Process Variable. $PV = \text{Input X} \times \text{RatioX} + \text{BiasX}$</p>

Function Prompt Lower Display	Selections or Range of Setting Upper Display	Parameter Definition
LOW VAL	Low Scale Value within the range of the selected variable to represent the minimum output (0 or 4 mA)	<p>AUXILIARY OUTPUT LOW SCALING FACTOR— This is a value in engineering units used to represent all AUX OUT parameters except Output.</p> <p>For Output, this is a value in percent and can be any value between –5 % and +105 %. However, keep in mind that relay output types can only be scaled 0 % to 100 %.</p>
HIGH VAL	High Scale Value within the range of the selected variable to represent the maximum output (20 mA)	<p>AUXILIARY OUTPUT HIGH SCALING FACTOR— This is a value in engineering units used to represent all AUX OUT parameters except Output.</p> <p>For Output, this is a value in percent and can be any value between –5 % and +105 %. However, keep in mind that relay output types can only be scaled 0 % to 100 %.</p>
DIG INP1	<p>NONE</p> <p>TO MAN</p> <p>TO LSP</p> <p>TO 2SP</p> <p>TO 3SP</p> <p>TO DIR</p>	<p>DIGITAL INPUT 1 SELECTIONS—All selections are available for Input 1. The controller returns to its original state when contact opens, except when overruled by the keyboard.</p> <p>NO DIGITAL INPUT SELECTIONS</p> <p>TO MANUAL—Contact closure puts the affected loop into manual mode. Contact open returns controller to former mode.</p> <p>TO LOCAL SETPOINT—When a remote setpoint is configured, contact closure puts the controller into local setpoint 1. When contact opens, the controller returns to former operation—local or remote setpoint—unless SP Select key is pressed while digital input is active. If this happens, the controller will stay in the local setpoint mode when contact opens.</p> <p>TO LOCAL SETPOINT TWO—Contact closure puts the controller into local setpoint 2.</p> <p>TO LOCAL SETPOINT THREE—Contact closure puts the controller into local setpoint 3.</p> <p>TO DIRECT ACTION—Contact closure selects direct controller action.</p>

Function Prompt Lower Display	Selections or Range of Setting Upper Display	Parameter Definition
	<p>TO HOLD</p> <p>TO PID2</p> <p>PV 2IN</p> <p>RERUN</p> <p>TO RUN</p> <p>ToBEGIN</p> <p>STOP I</p> <p>MAN FS</p> <p>TO LOCK</p>	<p>TO HOLD—Contact closure suspends Setpoint Program or Setpoint Ramp. When contact reopens, the controller starts from the Hold point of the Ramp/Program unless the Ramp/Program was not previously started via the  key.</p> <p>This selection applies to either loop.</p> <p>TO PID2—Contact closure selects PID Set 2.</p> <p>PV=INPUT 2—Contact closure selects PV = Input 2.</p> <p>RERUN--Allows the Setpoint Programmer to be reset to the initial segment of its current cycle, unit stays in previous mode.</p> <p>RUN—Contact closure starts a stopped SP Ramp or Program. Upper left character blinks “R”. Reopening the contact puts controller in HOLD mode.</p> <p>This selection applies to either loop.</p> <p>EXTERNAL SP PROGRAM RESET—Contact closure resets SP Program back to the beginning of the first segment in the program and places the program in the HOLD mode. Program cycle number is not affected. Reopening switch has no effect.</p> <p>This selection applies to either loop.</p> <p>ATTENTION Once the last segment of the setpoint program has timed out, the controller enters the mode of action specified in the configuration data and the program cannot be reset to the beginning of the first segment by digital input closure.</p> <p>INHIBIT INTEGRAL (RESET)—Contact closure disables PID Integral (Reset) action.</p> <p>MANUAL FAILSAFE OUTPUT—Controller goes to Manual mode, output goes to the Failsafe value.</p> <p>ATTENTION This will cause a bump in the output when switching from Automatic to Manual. The switch back from Manual to Automatic is bumpless. When the switch is closed, the output can be adjusted from the keyboard.</p> <p>KEYBOARD LOCKOUT—Contact closure disables all keys. Lower display shows LOCKED if a key is pressed.</p>

Function Prompt Lower Display	Selections or Range of Setting Upper Display	Parameter Definition
	<p>TO Aout</p> <p>TIMER</p> <p>AM STA</p> <p>TO TUNE</p> <p>SP Init</p> <p>TRACK</p> <p>TO RSP</p> <p>RST FB</p> <p>To PURGE</p>	<p>AUTOMATIC OUTPUT—Contact closure sends output to the value set at Control prompt AUTO OUT when the controller is in the Automatic mode. Reopening the contact returns the controller to the normal output.</p> <p>ATTENTION Does not apply to Three Position Step Control.</p> <p>TIMER—Contact closure starts timer, if enabled. Reopening the switch has no effect.</p> <p>TO AUTO/MANUAL STATION—Contact closure causes the control loop to perform as follows: PV = Input 2 Action = Direct Control algorithm = PD+MR PID SET = 2 SP = LSP 2</p> <p>INITIATE LIMIT CYCLE TUNING—Contact closure starts the tuning process. The lower display shows TUNE ON. Opening the contact has no effect.</p> <p>SETPOINT INITIALIZATION—Contact closure forces the setpoint to the current PV value. Opening the contact has no effect.</p> <p>OUTPUT TRACKS INPUT 2—Contact closure allows Output to track Input 2. While the switch is open, the output is in accordance with its pre-defined functionality. When the switch is closed, the output value (in percent) will track the Input 2 percent of range value. When the switch is reopened, the output will start at this last output value and normal PID action will then take over control. The transfer is bumpless.</p> <p>TO REMOTE SETPOINT—Contact closure selects the Remote setpoint.</p> <p>EXTERNAL RESET FEEDBACK—Contact closure allows Input 2 to override the internal reset value.</p> <p>TO PURGE—Contact closure forces the loop to Manual mode with the output set to the Output High Limit configuration. MAN lights and the Output value is shown on the lower display. Opening the switch has no effect.</p> <p>ATTENTION Does not apply to Three Position Step Control.</p>

Function Prompt Lower Display	Selections or Range of Setting Upper Display	Parameter Definition
	<p>Lo FIRE</p> <p>MAN LAT</p> <p>PV Hold</p>	<p>LOW FIRE—Contact closure forces the loop to Manual mode with the output set to the Output Low Limit configuration. MAN lights and the Output value is shown on the lower display. Opening the switch has no effect.</p> <p>ATTENTION Does not apply to Three Position Step Control.</p> <p>MANUAL LATCHING—Contact closure transition forces the loop to Manual mode. Opening the switch has no effect. If the MAN/AUTO key is pressed while the switch is closed, the loop will return to Automatic mode.</p> <p>PROCESS VARIABLE HOLD—when the switch is closed, PV is frozen at last value. When switch opens, PV resumes.</p>
<p>DIG 1COMB</p>	<p>DISABLE</p> <p>+PID2</p> <p>+TO DIR</p> <p>+TO SP2</p> <p>+DIS AT</p> <p>+TO SP1</p> <p>+RUN</p>	<p>DIGITAL INPUT 1 COMBINATION SELECTIONS—This selection allows the specified function to occur in addition to the one chosen for DIG IN 1.</p> <p>DISABLE—Disables combination function.</p> <p>PLUS PID2—Contact closure selects PID Set 2.</p> <p>PLUS DIRECT ACTION—Contact closure selects direct controller action.</p> <p>PLUS SETPOINT 2—Contact closure puts the controller into setpoint 2.</p> <p>PLUS DISABLE ADAPTIVE TUNE—Contact closure disables Accutune process.</p> <p>PLUS SETPOINT 1—Contact closure puts the controller into setpoint 1.</p> <p>PLUS RUN SETPOINT PROGRAM/RAMP—Contact closure starts SP Program/Ramp if enabled.</p>
<p>DIG INP2</p>	<p>Same selections as for Digital Input 1</p>	<p>DIGITAL INPUT 2 SELECTIONS</p>
<p>DIG2COMB</p>	<p>Same selections as Digital Input 1 Combinations</p>	<p>DIGITAL INPUT 2 COMBINATIONS</p>

3.13 Communications Group

Introduction

The Communications group lets you configure the controller to be connected to a host computer via Modbus® or Ethernet TCP/IP protocol.

Introduction

A controller with a communications option looks for messages from the host computer. If these messages are not received within the configured shed time, the controller will SHED from the communications link and return to stand-alone operation. You can also set the SHED output mode and setpoint recall, and communication units.

Up to 99 addresses can be configured over this link. The number of units that can be configured depends on the link length, with 31 being the maximum for short link lengths and 15 drops being the maximum at the maximum link length.

Function Prompts

Table 3-13 Communications Group Function Prompts

Function Prompt Lower Display	Selections or Range of Setting Upper Display	Parameter Definition
Com ADDR	1 to 99	COMMUNICATIONS STATION ADDRESS —This is a number that is assigned to a controller that is to be used with the communications option. This number will be its address.
ComSTATE	DISABLE MODBUS	COMMUNICATIONS SELECTION DISABLE —Disables RS-485 communications option. MODBUS —Enables RS-485 Modbus RTU communication port.
IR ENABLE	DISABLE ENABLE	IR ENABLE —Disable/Enables IR communications port. ATTENTION If there are no IR communications transactions for four minutes, then the IR port automatically shuts down. It can be re-enabled by pressing any key on the front panel.
BAUD	4800 9600 19200 38400	BAUD RATE is the transmission speed in bits per second. This value is used for both RS-485 and IR Communications, but for IR Communications, values below 19200 baud are interpreted as being 19200 baud. 4800 BAUD 9600 BAUD 19200 BAUD 38400 BAUD

Function Prompt Lower Display	Selections or Range of Setting Upper Display	Parameter Definition																								
TX DELAY	1 to 500 milliseconds	TX DELAY —Configurable response-delay timer allows you to force the instrument to delay its response for a time period of from 1 to 500 milliseconds compatible with the host system hardware/software.																								
WS FLOAT	FP_B FP_BB FP_L FP_LB	Defines word/byte order of floating point data for communications. Byte values: <table style="margin-left: 40px;"> <tr> <td style="text-align: center;">0</td> <td style="text-align: center;">1</td> <td style="text-align: center;">2</td> <td style="text-align: center;">3</td> </tr> <tr> <td style="text-align: center;">seeeeeee</td> <td style="text-align: center;">emmmmmmm</td> <td style="text-align: center;">mmmmmmmm</td> <td style="text-align: center;">mmmmmmmm</td> </tr> </table> Where: s = sign, e = exponent, m = mantissa bit <table style="margin-left: 40px;"> <tr> <td style="text-align: center;">0</td> <td style="text-align: center;">1</td> <td style="text-align: center;">2</td> <td style="text-align: center;">3</td> </tr> <tr> <td style="text-align: center;">1</td> <td style="text-align: center;">0</td> <td style="text-align: center;">3</td> <td style="text-align: center;">2</td> </tr> <tr> <td style="text-align: center;">3</td> <td style="text-align: center;">2</td> <td style="text-align: center;">1</td> <td style="text-align: center;">0</td> </tr> <tr> <td style="text-align: center;">2</td> <td style="text-align: center;">3</td> <td style="text-align: center;">0</td> <td style="text-align: center;">1</td> </tr> </table>	0	1	2	3	seeeeeee	emmmmmmm	mmmmmmmm	mmmmmmmm	0	1	2	3	1	0	3	2	3	2	1	0	2	3	0	1
0	1	2	3																							
seeeeeee	emmmmmmm	mmmmmmmm	mmmmmmmm																							
0	1	2	3																							
1	0	3	2																							
3	2	1	0																							
2	3	0	1																							
SHED ENAB	DISABLE ENABLE	SHED ENABLE —Disables/enables shed functionality. Applies to Modbus protocol only.																								
SHEDTIME	0 to 255	SHED TIME —The number that represents how many sample periods there will be before the controller sheds from communications. Each period equals 1/3 seconds; 0 equals No shed. Note: If ComSTATE is set to MODBUS or MB3K and if SHEDENAB is set to DISABL, Shed Time will not be configurable.																								
SHEDMODE	LAST TO MAN FSAFE TO AUTO	SHED CONTROLLER MODE AND OUTPUT LEVEL —Determines the mode of local control you want when the controller is shed from the communications link. LAST —SAME MODE AND OUTPUT—The controller will return to the same mode (manual or automatic) at the same output level that it had before shed. TO MAN —MANUAL MODE, SAME OUTPUT—The controller will return to manual mode at the same output level that it had before shed. FSAFE —MANUAL MODE, FAILSAFE OUTPUT—The controller will return to manual mode at the output value selected at Control prompt FAILSAFE. TO AUTO —AUTOMATIC MODE, LAST SP—The controller will return to the automatic mode and the last setpoint used before shed.																								

Function Prompt Lower Display	Selections or Range of Setting Upper Display	Parameter Definition
SHED SP	TO LSP TO CSP	<p>SHED SETPOINT RECALL</p> <p>Note: If SHEDENAB=DISABLE, this prompt will not be configurable.</p> <p>TO LSP—Controller will use last local or remote setpoint used.</p> <p>TO CSP—When in “slave” mode, the controller will store the last host computer setpoint and use it at the Local setpoint. When in “monitor” mode, the controller will shed to the last instrument Local or Remote setpoint used, and the LSP is unchanged.</p>
UNITS	ENG PERCENT	<p>COMPUTER SETPOINT UNITS</p> <p>ENG — Engineering units</p> <p>PERCENT — Percent of PV range</p>
CSP RATO	–20.0 to 20.0	COMPUTER SETPOINT RATIO —Computer setpoint ratio.
CSP BIAS	–999. to 9999. (engineering units)	COMPUTER SETPOINT BIAS —Computer setpoint bias in Engineering Units.
LOOPBACK	DISABLE ENABLE	<p>LOCAL LOOPBACK tests the RS-485 communications port. It is not used for any other communications port.</p> <p>DISABLE—Disables the Loopback test.</p> <p>ENABLE—Allows loopback test. The instrument goes into Loopback mode in which it sends and receives its own message. The instrument displays PASS or FAIL status in the upper display and LOOPBACK in the lower display while the test is running. The instrument will go into manual mode when LOOPBACK is enabled with the output at the Failsafe value. The test will run until the operator disables it here, or until power is turned off and on.</p> <p>ATTENTION The instrument does not have to be connected to the external communications link in order to perform this test. If it is connected, only one instrument should run the loopback test at a time. The host computer should not be transmitting on the link while the loopback test is active.</p>

3.14 Alarms Set Up Group

Introduction

An alarm is an indication that an event that you have configured (for example—Process Variable) has exceeded one or more alarm limits. There are two alarms available. Each alarm has two setpoints. You can configure each of these two setpoints to alarm on various controller parameters.

There are two alarm output selections, High and Low. You can configure each setpoint to alarm either High or Low. These are called single alarms.

You can also configure the two setpoints to alarm on the same event and to alarm both high and low. A single adjustable Hysteresis of 0 % to 100 % is configurable for the alarm setpoint.

See Table 2-3 in the Installation section for Alarm relay contact information.

The prompts for the Alarm Outputs appear whether or not the alarm relays are physically present. This allows the Alarm status to be shown on the display and/or sent via communications to a host computer.

Function Prompts

Table 3-14 ALARMS Group Function Prompts

Function Prompt Lower Display	Selections or Range of Setting Upper Display	Parameter Definition
A1S1 VAL	Value in engineering units	ALARM 1 SETPOINT 1 VALUE —This is the value at which you want the alarm type chosen in prompt A1S1TYPE to actuate. The value depends on what the setpoint has been configured to represent. No setpoint is required for alarms configured for Communications SHED. For SP Programming the value is the segment number for which the event applies. This prompt does not appear for “Alarm on Manual” type alarm. For example: A1S1TYPE = MANUAL.
A1S2 VAL	Value in engineering units	ALARM 1 SETPOINT 2 VALUE —This is the value at which you want the alarm type chosen in prompt A1S2TYPE to actuate. The details are the same as A1S1 VAL.
A2S1 VAL	Value in engineering units	ALARM 2 SETPOINT 1 VALUE —This is the value at which you want the alarm type chosen in prompt A2S1TYPE to actuate. The details are the same as A1S1 VAL.
A2S2 VAL	Value in engineering units	ALARM 2 SETPOINT 2 VALUE —This is the value at which you want the alarm type chosen in prompt A2S2TYPE to actuate. The details are the same as A1S1 VAL.

Function Prompt Lower Display	Selections or Range of Setting Upper Display	Parameter Definition
<p>A1S1TYPE</p>	<p>NONE INPUT 1 INPUT 2 PV DEV OUTPUT SHED EV ON EV OFF MANUAL REM SP F SAFE PV RATE DIG INP 1 DIG INP 2 DEV 2 BREAK TCWARN TCFAIL PVHOLD</p>	<p>ALARM 1 SETPOINT 1 TYPE—Select what you want Setpoint 1 of Alarm 1 to represent. It can represent the Process Variable, Deviation, Input 1, Input 2, Output, and if you have a model with communications, you can configure the controller to alarm on SHED. If you have setpoint programming, you can alarm when a segment goes ON or OFF.</p> <p>NO ALARM INPUT 1 INPUT 2 PROCESS VARIABLE DEVIATION OUTPUT (NOTE 1) SHED FROM COMMUNICATIONS EVENT ON (SP PROGRAMMING) EVENT OFF (SP PROGRAMMING) ALARM ON MANUAL MODE (NOTE 2) REMOTE SETPOINT FAILSAFE PV RATE OF CHANGE DIGITAL INPUT 1 ACTUATED (NOTE 7) DIGITAL INPUT 2 ACTUATED (NOTE 7) DEVIATION FROM LSP 2 (NOTE 3) LOOP BREAK (NOTE 4) THERMOCOUPLE WARNING (NOTE 5) THERMOCOUPLE FAIL (NOTE 6) PV HOLD</p> <p>ATTENTION</p> <p>NOTE 1. When the controller is configured for Three Position Step Control, alarms set for Output will not function.</p> <p>NOTE 2. Alarm 1 is not available if the Timer is enabled because Alarm 1 is dedicated to Timer output.</p> <p>NOTE 3. This Deviation Alarm is based upon deviation from the 2nd Local Setpoint or Remote SP regardless of whichever SP is active.</p> <p>NOTE 4. Loop Break monitors the control loop to determine if it is working. When enabled, the control output is checked against the minimum and maximum output limit settings. When the output reaches one of these limits, a timer begins. If the timer expires and the output has not caused the PV to move by a pre-determined amount, then the alarm activates, thus signalling that the loop is broken. The loop break timer value must be configured by the operator as the AxSx VAL entry. This value is in seconds with a range of 0 to 3600 seconds. A setting of 0 is equivalent to an instantaneous loop break when the output reaches one of its limit</p>

Function Prompt Lower Display	Selections or Range of Setting Upper Display	Parameter Definition
A1S2TYPE	Same as A1S1 TYPE	ALARM 1 SETPOINT 2 TYPE —Select what you want Setpoint 2 of Alarm 1 to represent. The selections are the same as A1S1TYPE.
A1S2 H L A1S2 EV	HIGH LOW BEGIN END	ALARM 1 SETPOINT 2 STATE —Same as A1S1 H L. ALARM 1 SEGMENT EVENT 2 —Same as A1S1 EV.
A2S1TYPE	Same as A1S1 TYPE	ALARM 2 SETPOINT 1 TYPE —Select what you want Setpoint 1 of Alarm 2 to represent. The selections are the same as A1S1TYPE. ATTENTION Not available with Relay Duplex or Position Proportional output types unless using Dual Relay PWA.
A2S1 H L A2S1 EV	HIGH LOW BEGIN END	ALARM 2 SETPOINT 1 STATE —Same as A1S1 H L. ALARM 2 SEGMENT EVENT 1 —Same as A1S1 EV.
A2S2TYPE	Same as A1S1 TYPE	ALARM 2 SETPOINT 2 TYPE —Select what you want Setpoint 2 of Alarm 2 to represent. The selections are the same as A1S1TYPE. ATTENTION Not applicable with Relay Duplex or Position Proportional output types unless using Dual Relay PWA.
A2S2 H L A2S2 EV	HIGH LOW BEGIN END	ALARM 2 SETPOINT 2 STATE —Same as A1S1 H L. ALARM 2 SEGMENT EVENT 2 —Same as A1S1 EV.
ALHYST	0.0 to 100.0 % of span or full output as appropriate	ALARM HYSTERESIS —A single adjustable hysteresis is provided on alarms such that when the alarm is OFF it activates at exactly the alarm setpoint; when the alarm is ON, it will not deactivate until the variable is 0.0 % to 100 % away from the alarm setpoint. Configure the hysteresis of the alarms based on INPUT signals as a % of input range span. Configure the hysteresis of the alarm based on OUTPUT signals as a % of the full scale output range.

Function Prompt Lower Display	Selections or Range of Setting Upper Display	Parameter Definition
ALM OUT1	NoLATCH LATCH	<p>LATCHING ALARM OUTPUT 1—Alarm output 1 can be configured to be Latching or Non-latching.</p> <p>NoLATCH —Non-latching LATCH—Latching</p> <p>ATTENTION When configured for latching, the alarm will stay active after the alarm condition ends until the RUN/HOLD key is pressed.</p>
BLOCK	DISABLE ALARM 1 ALARM 2 ALARM12	<p>ALARM BLOCKING—Prevents nuisance alarms when the controller is first powered up. The alarm is suppressed until the parameter gets to the non-alarm limit or band. Alarm blocking affects both alarm setpoints.</p> <p>DISABLE—Disables blocking ALARM 1—Blocks alarm 1 only ALARM 2—Blocks alarm 2 only ALARM12—Blocks both alarms</p> <p>ATTENTION When enabled on power up or initial enabling via configuration, the alarm will not activate unless the parameter being monitored has not been in an alarm condition for a minimum of one control cycle (167 ms).</p>
DIAGNOST	DISABLE ALARM 1 ALARM 2	<p>DIAGNOSTIC—Monitors the Current Output and/or Auxiliary Output for an open circuit condition. If either of these two outputs falls below about 3.5 mA, then an Alarm is activated. This configuration is in addition to whatever was selected for AxSxTYPE.</p> <p>DISABLE—Disables Diagnostic Alarm ALARM 1—Alarm 1 is diagnostic alarm ALARM 2—Alarm 2 is diagnostic alarm</p>

3.15 Display Set Up Group

Introduction

This group includes selections for Decimal place, Units of temperature, Language and Power frequency.

Function Prompts

Table 3-15 DISPLAY Group Function Prompts

Function Prompt Lower Display	Selections or Range of Setting Upper Display	Parameter Definition
DECIMAL	NONE ONE TWO THREE	<p>DECIMAL POINT LOCATION—This selection determines where the decimal point appears in the display.</p> <p>NONE—No Decimal Place—fixed, no auto-ranging ONE—One Place TWO—Two Places THREE—Three Places</p> <p>ATTENTION Auto-ranging will occur for selections of one, two or three decimal places. For example, should the instrument be configured for two decimal places and the PV exceeds 99.99, then the display will change to a single decimal place so that values of 100.0 and above can be shown.</p>
TEMP UNIT	DEG F DEG C NONE	<p>TEMPERATURE UNITS—This selection will affect the indication and operation.</p> <p>DEG F—Degrees Fahrenheit – Degrees F Annunciator lighted DEG C—Degrees Centigrade – Degrees C Annunciator lighted NONE—No temperature annunciators lighted. Upper and Lower Displays will show temperature in Degrees Fahrenheit when inputs are configured for Thermocouple or RTD types.</p>
PWR FREQ	60 HZ 50 HZ	<p>POWER LINE FREQUENCY—Select whether your controller is operating at 50 or 60 Hertz.</p> <p>ATTENTION For controllers powered by +24 Vdc, this configuration should be set to the AC line frequency used to produce the +24 Vdc supply.</p> <p>Incorrect setting of this parameter may cause normal mode noise problems in the input readings.</p>
RATIO 2	DISABLE	<p>INPUT 2 RATIO—This enables the Ratio for Input 2 to be set from the front panel. Input 2 must be installed and enabled for this configuration to operate.</p> <p>DISABLE—Disables setting Ratio 2 from front panel.</p>

Configuration

Function Prompt Lower Display	Selections or Range of Setting Upper Display	Parameter Definition
	ENABLE	ENABLE —Allows the Ratio for Input 2 to be set through the keyboard.
LANGUAGE	ENGLISH FRENCH GERMAN SPANISH ITALIAN	LANGUAGE —This selection designates the prompt language. ENGLISH FRENCH GERMAN SPANISH ITALIAN

3.16 Configuration Record Sheet

Enter the value or selection for each prompt on this sheet so you will have a record of how your controller was configured.

Group Prompt	Function Prompt	Value or Selection	Factory Setting	Group Prompt	Function Prompt	Value or Selection	Factory Setting
TUNING	PROP BD	_____	--	ALGORITHM	CONT ALG	_____	PID A
	or				TIMER	_____	DISABLE
	GAIN	_____	1.000		PERIOD	_____	0.01
	or				START	_____	KEY
	GAINVALn	Read Only	--		LOW DISP	_____	TI REM
	RATE MIN	_____	0.00		RESET	_____	KEY
	RSET MIN	_____	1.00		INCREMENT	_____	MINUTES
	or				INP ALG1	_____	NONE
	RSET RPM	_____	--		MATH K	_____	1.0
	MAN RSET	_____	0		CALC HI	_____	--
	PROPB2	_____	--	CALC LO	_____	--	
	or			ALG1 INA	_____	INPUT 1	
	GAIN 2	_____	1.000	ALG1 INB	_____	INPUT 2	
	RATE2MIN	_____	0.00	ALG1 INC	_____	NONE	
	RSET2MIN	_____	1.00	ALG1BIAS	_____	0.000	
	or			PCT CO	_____	0.200	
	RSET2RPM	_____	--	OUT ALG	OUT ALG	_____	NOTE 1
	CYC SEC	_____	20		RLYSTATE	_____	1OF 2ON
	or				RLY TYPE	_____	MECHAN
	CYC SX3	_____	20		MOTOR TI	_____	30
CYC2 SEC	_____	20	CUR OUT		_____	DISABLE	
or			CO RANGE		_____	4-20mA	
CYC2 SX3	_____	20	LOW VAL		_____	0.0	
SECURITY	_____	0	HIGH VAL		_____	100.0	
LOCKOUT	_____	CALIB					
AUTO MAN	_____	ENABLE					
RUN HOLD	_____	ENABLE					
SP SEL	_____	ENABLE					
SP RAMP	SP RAMP	_____	DISABLE	INPUT 1	IN1 TYPE	_____	0-10mV
	TIME MIN	_____	3		XMITTER1	_____	LINEAR
	FINAL SP	_____	1000		IN1 HIGH	_____	1000
	SP RATE	_____	DISABLE		IN1 LOW	_____	0
	EU/HR UP	_____	0		RATIO 1	_____	1.00
	EU/HR DN	_____	0		BIAS IN1	_____	0
	HOTSTART	_____	DISABLE		FILTER 1	_____	1
SP PROG	_____	DISABLE	BURNOUT1	_____	NONE		
			EMMISIV1	_____	0.00		
ACCUTUNE	FUZZY	_____	DISABLE	INPUT 2	IN2 TYPE	_____	0-10mV
	ACCUTUNE	_____	DISABLE		XMITTER2	_____	LINEAR
	DUPLEX	_____	MANUAL		IN2 HIGH	_____	1000
	AT ERROR	Read Only	NONE		IN2 LOW	_____	0
			RATIO 2		_____	1.00	
			BIAS IN2		_____	0	
			FILTER 2		_____	1	
			BURNOUT2		_____	NONE	
			EMMISIV2	_____	0.00		

NOTE 1: Model Number dependent.

Group Prompt	Function Prompt	Value or Selection	Factory Setting	Group Prompt	Function Prompt	Value or Selection	Factory Setting
CONTROL	PV SOURC	_____	INPUT 1	ALARMS	A1S1TYPE	_____	NONE
	PID SETS	_____	1 ONLY		A1S1 VAL	_____	90
	SW VALUE	_____	0.00		A1S1 H L	_____	HIGH
	LSP'S	_____	1 ONLY		A1S1 EV	_____	--
	RSP SRC	_____	NONE		A1S2TYPE	_____	NONE
	AUTOBIAS	_____	DISABLE		A1S2 VAL	_____	10
	SP TRACK	_____	NONE		A1S2 H L	_____	LOW
	PWR MODE	_____	MANUAL		A1S2 EV	_____	--
	PWR OUT	_____	LAST		A2S1TYPE	_____	NONE
	SP HiLIM	_____	1000		A2S1 VAL	_____	95
	SP LoLIM	_____	0		A2S1 H L	_____	HIGH
	ACTION	_____	REVERSE		A2S1 EV	_____	--
	OUT RATE	_____	DISABLE		A2S2TYPE	_____	NONE
	PCT/M UP	_____	0		A2S2 VAL	_____	5
	PCT/M DN	_____	0		A2S2 H L	_____	LOW
	OUTHILIM	_____	100		A2S2 EV	_____	--
	OUTLoLIM	_____	0.0		AL HYST	_____	0.1
	I Hi LIM	_____	100.0		ALM OUT1	_____	NoLATCH
	I Lo LIM	_____	0.0		BLOCK	_____	DISABLE
	DROPOFF	_____	0		DIAGNOST	_____	DISABLE
	DEADBAND	_____	1.0				
	OUT HYST	_____	0.5				
	FAILMODE	_____	NoLATCH				
	FAILSAFE	_____	0.0				
	MAN OUT	_____	0.0				
	AUTO OUT	_____	0.0				
PBoRGAIN	_____	GAIN					
MINoRRPM	_____	MIN					
OPTIONS	AUX OUT	_____	DISABLE	DISPLAY	DECIMAL	_____	NONE
	CO RANGE	_____	4-20mA		TEMPUNIT	_____	NONE
	LOW VAL	_____	0.0		PWR FREQ	_____	60 HZ
	HIGH VAL	_____	100.0		RATIO 2	_____	DISABLE
	DIG INP1	_____	NONE		LANGUAGE	_____	ENGLISH
	DIG1COMB	_____	DISABLE				
	DIG INP2	_____	NONE				
	DIG2COMB	_____	DISABLE				
COM	Com ADDR	_____	3	Ethernet (Accessible via PIE Tool)	MAC Add.	_____	--
	ComSTATE	_____	DISABLE		IP Address	_____	10.0.0.2
	IR ENABLE	_____	ENABLE		Subnet Mask	_____	225.225.225.0
	BAUD	_____	19200		Default Gate	_____	0.0.0.0
	TX DELAY	_____	1		To Email	_____	--
	WS FLOAT	_____	FP B		SMTP Add.	_____	0.0.0.0
	SHEDENAB	_____	DISABLE		Alarm	_____	NONE
	SHEDTIME	_____	30.0		Email Subj	_____	--
	SHEDMODE	_____	LAST				
	SHEDSP	_____	TO LSP				
	UNITS	_____	PERCNT				
	CSP RATO	_____	1.0				
	CSP BIAS	_____	0				
	LOOPBACK	_____	DISABLE				

4 Monitoring and Operating the Controller

4.1 Overview

Introduction

This section gives you all the information necessary to help you monitor and operate your controller including an Operator Interface overview, how to lockout changes to the controller, entering a security code, and monitoring the displays.

What's in this section?

The following topics are covered in this section.

TOPIC	See Page
4.1 Overview	97
4.2 Operator Interface	98
4.3 Entering A Security Code	98
4.4 Lockout Feature	99
4.5 Monitoring The Controller	101
4.6 Start Up Procedure for Operation	104
4.7 Control Modes	106
4.8 Setpoints	107
4.9 Timer	108
4.10 Accutune	110
4.11 Fuzzy Overshoot Suppression	117
4.12 Using Two Sets Of Tuning Constants	117
4.13 Alarm Setpoints	119
4.14 Three Position Step Control Algorithm	121
4.15 Setting A Failsafe Output Value For Restart After A Power Loss	122
4.16 Setting Failsafe Mode	123
4.17 Setpoint Rate/Ramp/Program Overview	123
4.18 Setpoint Rate	124
4.19 Setpoint Ramp	124
4.20 Setpoint Ramp/Soak Programming	126

4.2 Operator Interface

Introduction

Figure 4-1 is a view of the Operator Interface.



Figure 4-1 Operator Interface

4.3 Entering a Security Code

Introduction





The level of keyboard lockout may be changed in the Set Up mode. However, knowledge of a security code number (0 to 9999) may be required to change from one level of lockout to another. When a controller leaves the factory, it has a security code of 0 which permits changing from one lockout level to another without entering any other code number.

Procedure

If you require the use of a security code, select a number from 0001 to 9999 and enter it when the lockout level is configured as NONE. Thereafter, that selected number must be used to change the lockout level from something other than NONE.

ATTENTION Write the number on the Configuration Record Sheet in the configuration section so you will have a permanent record.

Table 4-1 Procedure to Enter a Security Code

Step	Operation	Press	Result
1	Enter Set Up Mode		Upper Display = SET UP Lower Display = TUNING
2	Select any Set Up Group		Upper Display = 0 Lower Display = SECUR
3	Security Code Entry	 or 	To enter a four digit number in the upper display (0001 to 9999) This will be your security code.

4.4 Lockout Feature

Introduction

The lockout feature in the UDC3200 is used to inhibit changes (via keyboard) of certain functions or parameters by unauthorized personnel.

Lockout levels

There are different levels of Lockout depending on the level of security required. These levels are:

- **NONE** No Lockout. All groups Read/Write.
- **CALIB** Calibration prompts are deleted from the Setup List.
- **+CONFIG** Timer, Tuning, SP Ramp, and Accutune are Read/Write. All other Setup are Read only. Calibration Group is not available.
- **+VIEW** Timer, Tuning, and SP Ramp are Read/Write. No other parameters are available.
- **ALL** Timer, Tuning, and SP Ramp are Read only. No other parameters are viewable.

See *Subsection 3.4 - Tuning Parameters Set Up Group* prompts to select one of the above.

Security Code (*see Subsection 4.3*)

Individual key lockout

There are three keys that can be disabled to prevent unauthorized changes to the parameters associated with these keys. *First set the “Lock” prompt to NONE.*

These keys are:



Key

- you can disable the Run/Hold key for Set Point Programming at configuration Set Up group prompt “Tuning,” function prompt “RN HLD.”



Key

- you can disable the Auto/Manual key at configuration Set Up, group prompt “Tuning”, function prompt “AUTOMA”



Key

- you can disable the Set Point Select function key at configuration Set Up group prompt “Tuning,” function prompt “SP SEL.”

See *Subsection 3.4 - Tuning Parameters Set Up Group* prompts to enable or disable these keys.

Key error

When a key is pressed and the prompt “Key Error” appears in the lower display, it will be for one of the following reasons:

- Parameter not available or locked out
- Not in setup mode, press **SET UP** key first
- Individual key locked out.

4.5 Monitoring Your Controller

4.5.1 Annunciators

The following annunciator functions have been provided to help monitor the controller:

Table 4-2 Annunciators

Annunciator	Indication
ALM 1 2	<p><i>A visual indication of each alarm</i></p> <p>Blinking 1 indicates an alarm latched condition. The blinking will continue even after the alarm condition ends until it is acknowledged by pressing the RUN/HOLD key.</p>
OUT 1 2	<p><i>A visual indication of the control relays</i></p>
DI 1 2	<p><i>A visual indication of each Digital Input</i></p>
A or MAN	<p><i>A visual indication of the mode of the controller)</i></p> <p>A—Automatic Mode</p> <p>MAN—Manual Mode</p>
[None], F or C	<p><i>A visual indication of the temperature units</i></p> <p>[None]—No temperature unit annunciator</p> <p>F—Degrees Fahrenheit</p> <p>C—Degrees Celsius</p>
n	<p><i>A visual Lamp to indicate when the lower display is showing the Active Setpoint (Local 1, Local 2, Local 3, Remote Setpoint or Computer Setpoint)</i></p> <p><i>The upper left digit of the display is used to show other annunciator functions</i></p> <p>T—Accutuning in process</p> <p>C—Computer override active</p> <p>O—Output override active</p>

4.5.2 Viewing the operating parameters

Press the **LOWER DISPLAY** key to scroll through the operating parameters listed in Table 4-3. The lower display will show only those parameters and their values that apply to your specific model.

Table 4-3 Lower Display Key Parameter Prompts

Lower Display	Description
OUT XX.X	OUTPUT—Output value is shown in percent with one decimal point for all output types except Three Position Step Control (TPSC). For TPSC, when no slidewire is connected, this display is an estimated motor position and is shown with no decimal point. For Position Proportional Control, if the slidewire fails, then the instrument automatically switches over to TPSC and the OUT display changes with it.
SP XXXX	LOCAL SETPOINT #1—Also current setpoint when using SP Ramp.
2SP XXXX	LOCAL SETPOINT #2
3SP XXXX	LOCAL SETPOINT #3
RSP XXXX	REMOTE SETPOINT
1IN XXXX	INPUT 1—Used only with combinational input algorithms.
2IN XXXX	INPUT 2
POS XX	SLIDEWIRE POSITION—Used only with TPSC applications that use a slidewire input.
CSP XXXX	COMPUTER SETPOINT—When SP is in override.
DEV XXXX	DEVIATION—Maximum negative display is -999.9.
PIDSET X	TUNING PARAMETER —where X is either 1 or 2.
ET HR.MN	ELAPSED TIME—Time that has elapsed on the Timer in Hours.Minutes.
OTR HR.MN	TIME REMAINING—Time remaining on the Timer in Hours.Minutes. The “O” is a rotating clock face.
RAMPXXXM	SETPOINT RAMP TIME—Time remaining in the Setpoint Ramp in minutes.
SPN XXXX	SETPOINT NOW—Current Setpoint when SP Rate is enabled. The SP XXXX display shows the “target” or final setpoint value.
XXRAHR.MN	RAMP SEGMENT NUMBER AND TIME REMAINING—Set Point Programming display. XX is the current segment number and HR.MN is the time remaining for this segment in Hours.Minutes.
XXSKHR.MN	SOAK SEGMENT NUMBER AND TIME REMAINING— Set Point Programming display. XX is the current segment number and HR.MN is the time remaining for this segment in Hours.Minutes.
RECYC XX	NUMBER OF SP PROGRAM RECYCLES REMAINING
To BEGIN	RESET SP PROGRAM TO START OF FIRST SEGMENT
RERUN	RESET SP PROGRAM TO START OF CURRENT SEGMENT
AUX XXXX	AUXILIARY OUTPUT—Displayed only when output algorithm is not Current Duplex.
BIA XXXX	BIAS—Displays the manual reset value for algorithm PD+MR.
TUNE OFF	LIMIT CYCLE TUNING NOT RUNNING—Appears when Accutune is enabled but not operating.
DO FAST	Limit Cycle Tuning with the objective of producing quarter-damped tuning parameters. This tuning may result in PV overshoot of the SP setting.
DO SLOW	Limit Cycle Tuning with the objective of producing damped or Dahlin tuning parameters, depending upon the detected process deadtime. The tuning parameters calculated by this selection are aimed at reducing PV overshoot of the SP setting.

4.5.3 Diagnostic Messages

The UDC3200 performs background tests to verify data and memory integrity. If there is a malfunction, a diagnostic message will be shown on the lower display. In the case of more than one simultaneous malfunction, only the highest priority diagnostic message will be displayed. Table 4-4 shows the error messages in order by priority. If any of these diagnostic messages appear on the lower display, refer to *Section 7 - Troubleshooting* for information on how to correct the problem.

Table 4-4 Diagnostic Messages

Prompt	Description
EE FAIL	Unable to write to nonvolatile memory. A subsequent successful write to nonvolatile memory removes this message.
FAILSAFE	This error message appears whenever the controller goes into a failsafe mode of operation. Failsafe operation occurs when an analog input fails or when configuration is corrupted.
INP1FAIL	Two consecutive failures of input 1 integration or input value is outside of Out-of-Range limits.
INP2FAIL	Two consecutive failures of input 2 integration or input value is outside of Out-of-Range limits.
SW FAIL	Slidewire input failure. Position Proportional Control automatically switched to Three Position Step Control.
CONF ERR	Configuration Errors—Low limit greater than high limit for PV, SP, Reset, or Output.
SOOTING	Carbon Potential Problem—Percent Carbon outside of “sooting boundary.”
IN1 RNG	Input 1 Out-of-Range—Input is outside of the High or Low Limits. Out-of-range criteria: Linear range: $\pm 10\%$ Characterized range: $\pm 1\%$
IN2 RNG	Input 2 Out-of-Range—Same criteria as Input 1.
PV LIMIT	PV beyond limits—PV outside of PV Hi/Low Limits. $PV = (PV \text{ source} \times PV \text{ source ratio}) + PV \text{ source bias}$
FAILSAFE	Failsafe—Check inputs or configuration.
RV LIMIT	Remote Variable beyond limits—RSP outside of SP Hi/Low Limits. $RV = (RV \text{ source} \times RV \text{ source ratio}) + RV \text{ source bias}$
SEG ERR	Segment Error—SP Program starting segment number is less than ending segment number.
CAL MTR	Slidewire not calibrated. Perform Slidewire calibration.
SW FAIL	Position Proportional slidewire input failure.
TC1 WARN	The Thermocouple on Input 1 is starting to burnout.
TC2 WARN	The Thermocouple on Input 2 is starting to burnout.
TC1 FAIL	Thermocouple on Input 1 is in imminent danger of burning out.

Prompt	Description
TC2 FAIL	Thermocouple on Input 2 is in imminent danger of burning out.
OUT1FAIL	Current Output is less than 3.5 mA.
OUT2FAIL	Current Output 2 is less than 3.5 mA.

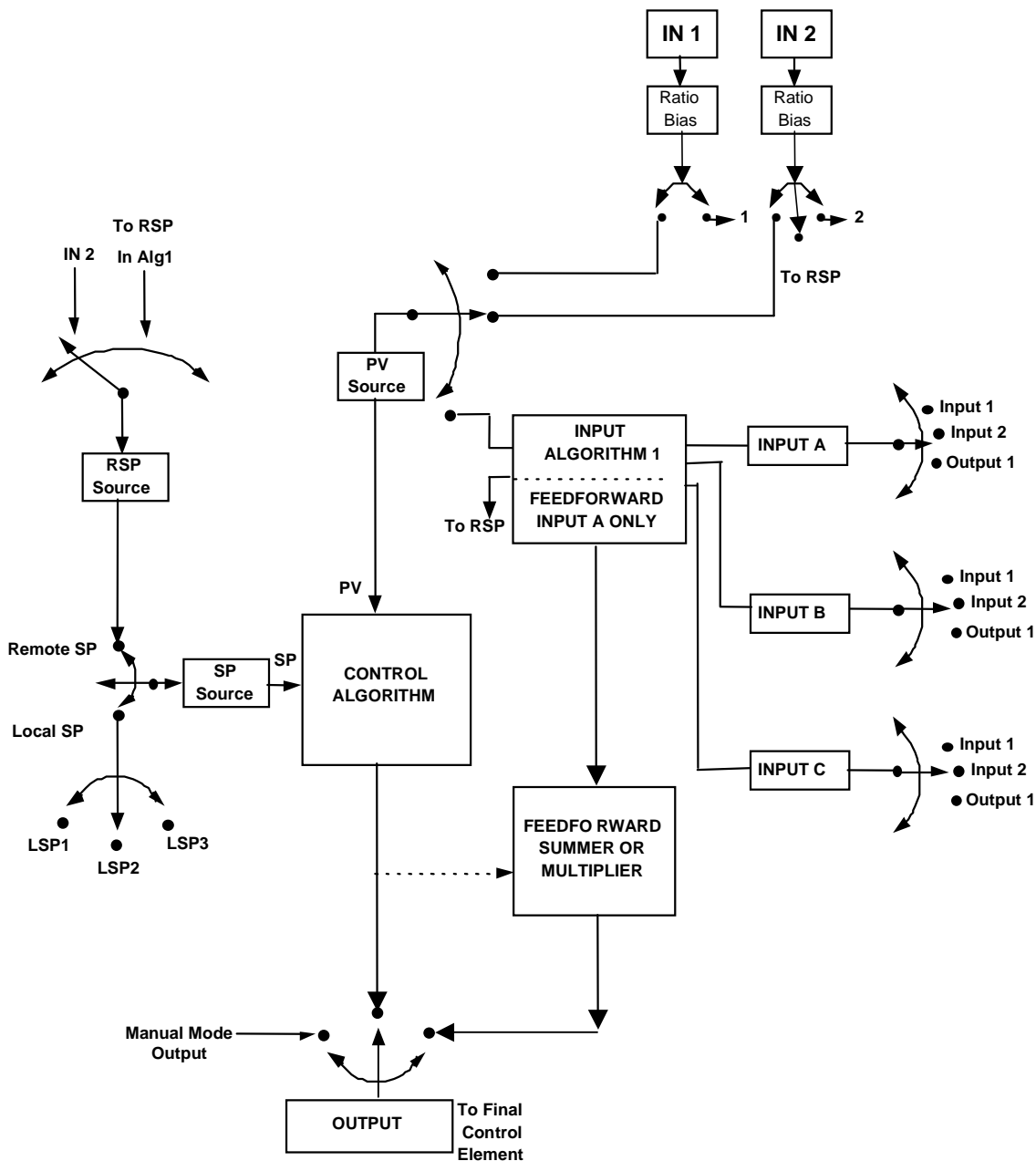





Figure 4-2 Functional Overview Block Diagram of the UDC3200 Controller

4.6 Start Up Procedure for Operation

Table 4-5 Procedure for Starting Up the Controller

Step	Operation	Press	Result
1	Select Manual Mode		Until "M" indicator is ON. The controller is in manual mode.
2	Adjust the Output	▲OR▼	To adjust the output value and ensure that the final control element is functioning correctly. <i>Upper Display = PV Value</i> <i>Lower Display = OUT and the output value in %</i>
3	Enter the Local Setpoint	 ▲OR▼	<i>Upper Display = PV Value</i> <i>Lower Display = SP and the Local Setpoint Value</i> To adjust the local setpoint to the value at which you want the process variable maintained. The local setpoint cannot be changed if the Setpoint Ramp function is running.
4	Select Automatic Mode		Until "A" indicator is ON. The controller is in Automatic mode. The controller will automatically adjust the output to maintain the process variable at setpoint.
5	Tune the Controller		Make sure the controller has been configured properly and all the values and selections have been recorded on the Configuration Record Sheet. Refer to Tuning Set Up group to ensure that the selections for P or GAIN, RATE T, and I MIN, or I RPM have been entered. Use Accutune to tune the controller; see the procedure in this section.

4.7 Control Modes

ATTENTION

After changing a Local Setpoint value, if no other key is pressed, it then takes a minimum of thirty (30) seconds elapsed time before the new value is stored in non-volatile memory. If controller power is removed before this time, the new setpoint value is lost and the previous setpoint value is used at power-up. If, after changing the LSP value, another key is pressed, then the value is stored immediately.

4.7.1 Mode Definitions

Table 4-6 Control Mode Definitions

Control Mode	Definition
AUTOMATIC with LOCAL SETPOINT	In automatic local mode, the controller operates from the local setpoints and automatically adjusts the output to maintain the PV at the desired value. In this mode you can adjust the setpoint. <i>See Subsection 4.8 - Setpoints.</i>
AUTOMATIC with REMOTE SETPOINT (optional)	In automatic remote mode, the controller operates from the setpoint measured at the remote setpoint input. Adjustments are available to ratio this input and add a constant bias before it is applied to the control equation. <i>See Subsection 3.9 Input 1 or 3.10 Input 2.</i>
MANUAL (optional)	In the manual mode, the operator directly controls the controller output level. The process variable and the percent output are displayed. The configured High and Low Output Limits are disregarded and the operator can change the output value, using the increment and decrement keys, to the limits allowed by the output type (0 % to 100 % for a time proportioning output or -5 % to 105 % for a current output).

4.7.2 What happens when you change modes

Table 4-7 Changing Control Modes

Control Mode	Definition
Manual to Automatic Local Setpoint	<p>The Local Setpoint is usually the value previously stored as the Local Setpoint.</p> <p>PV tracking is a configurable feature which modifies this. For this configuration, when the controller is in manual mode, the local setpoint value tracks the process variable value continuously.</p>
Manual or Auto Local to Automatic Remote SP	<p>The Remote Setpoint uses the stored ratio and bias to calculate the control setpoint.</p> <p>Auto bias is a configurable feature which modifies this. When it is selected the transfer from automatic local to automatic remote or from manual remote to automatic remote adjusts the bias based on the local setpoint such that</p> $\text{Bias} = \text{LSP} - (\text{RSP Input} \times \text{R}).$
Automatic Remote Setpoint to Manual or Auto Local Setpoint	<p>If configured for local setpoint tracking, RSP, when the controller transfers out of remote setpoint the last value of the remote setpoint is inserted into the local setpoint.</p> <p>If LSP tracking is not configured, the local setpoint will not be altered when the transfer is made.</p>

4.8 Setpoints

Introduction





You can configure the following setpoints for the UDC3200 controller.

- A Single Local Setpoint
- 2 Local Setpoints
- 3 Local Setpoints
- Up to 3 Local Setpoint and one Remote Setpoint

Refer to *Subsection 3.11 – Control Set Up Group* for configuration details.

Changing the Setpoints

Table 4-8 Procedure for Changing the Local Setpoints

Step	Operation	Press	Result
1	Select the Setpoint		Until you see: <i>Upper Display = PV</i> <i>Lower Display = SP or 2SP or 3SP (Value)</i>
2	Change the Value	 or 	To change the Local Setpoint to the value at which you want the process maintained. The display “blinks” if you attempt to enter setpoint values beyond the high and low limits..
3	Return to PV Display		To store immediately or will store after 30 seconds.

Switching between setpoints

You can switch Local and Remote setpoints or between two Local setpoints when configured.

ATTENTION The REMOTE SETPOINT value cannot be changed at the keyboard.

Table 4-9 Procedure for Switching Between Setpoints

Step	Operation	Press	Result
1	Select the Setpoint		To switch between the Three Local Setpoints and/or the Remote Setpoint. ATTENTION “KEY ERROR” will appear in the lower display, if: <ul style="list-style-type: none"> • the remote setpoint or additional local setpoints are not configured as a setpoint source • you attempt to change the setpoint while a setpoint ramp is enabled, or • if you attempt to change the setpoint with the setpoint select function key disabled. • appears to the left of the active setpoint

4.9 Timer

Introduction

The Timer provides a configurable Time-out period of from 0 to 99 hours:59 minutes or 0 to 99 minutes:99 seconds.

Timer “Start” is selectable as either the **RUN/HOLD** key or Alarm 2.

The Timer display can be either “Time Remaining” or “Elapsed Time”.

Configuration check

Make sure:

- TIMER is enabled
- A TIMEOUT period has been selected (in hours and minutes or minutes and seconds)
- A TIMER FUNCTION START has been selected (KEY or AL2)
- A TIMER display has been selected (Time remaining or Elapsed time)
- A timer increment selected
- Timer reset selected

Refer to *Subsection 3.7 Algorithm Set Up Group* for details.

Viewing Times

The times are viewed on the lower display as follows:

TIME REMAINING will show as a *decreasing* Hrs:Min value (HH:MM) or Min:Sec value (MM:SS) plus a *counterclockwise* rotating clock face.

ELAPSED TIME will show as an *increasing* Hrs:Min value(HH:MM) or Min:Sec value (MM:SS) plus a *clockwise* rotating clock face.



Operation

When the Timer is enabled (RUN/HOLD key or ALARM 2), it has exclusive control of Alarm 1 relay.

At “TIME-OUT”:

- Alarm 1 is active
- The clock character has stopped moving
- The Time display shows either 00:00 or the time-out period depending on the configuration selection
- The Timer is ready to be reset

At “RESET”:

- Alarm 1 relay is inactive
- The time display shows the time-out period
- The time-out period can be changed at this time using the  or  keys.
- The Timer is ready to be activated

4.10 Accutune III

Introduction

Accutune III (TUNE) may be used for self-regulating and single integrating processes. This autotuning method is initiated on-demand, typically at initial start-up.

There are no other requirements necessary, such as prior knowledge to the process dynamics or initial or post tune process line-out to setpoint or manual output.

Also, the setpoint value is not required to change in order to initiate the tuning process, but the controller must be in the Automatic mode to start tuning. The process need not be in a static (lined out) state and may be dynamic (changing with a steady output).

Configuration check

Make sure:

- TUNE has been enabled see to *Subsection 3.6 - Accutune Set Up Group* for details.

Tuning indicators

A “T” will show in the leftmost alphanumeric of the upper display until tuning is completed.

Operation

The Accutune III algorithm provides user-friendly, on-demand tuning in this controller. No knowledge of the process is required at start-up. The operator simply initiates the tuning while in the automatic mode.

Once Accutune III has been enabled in the TUNE setup group, either “SLOW” or “FAST” tuning may be used. Which one is used is selected via the lower display during normal operation.

For the SLOW selection, the controller calculates conservative tuning constants with the objective of minimizing overshoot. If the controller determines that the process has appreciable dead time, it will automatically default to use Dahlin Tuning, which produces very conservative tuning constants. The SLOW selection may be useful for TPSC and Position Proportional applications, as it reduces “hunt” problems for the motor. This selection is also recommended for applications that have significant deadtimes.

For the FAST selection, the controller calculates aggressive tuning constants with the objective of producing quarter damped response. Depending upon the process, this selection will usually result in some overshoot. For this reason, it may be desirable to enable the FUZZY tune selection. See Section 4.11. When Fuzzy tune is enabled, it will work to suppress or eliminate any overshoot that may occur as a result of the calculated tuning parameters as the PV approaches the setpoint. This selection is best suited for processes with a single lag or for those that do not have any appreciable deadtime. FUZZY tuning does not work well for processes that have appreciable deadtime.





The Accutune III tuning process will cycle the controller’s output two full cycles between the low and high output limits while allowing only a very small Process Variable change above and below the SP during each cycle. A “T” shows in the upper display until tuning is completed.



At the end of the tuning process, the controller immediately calculates the tuning constants and enters them into the Tuning group, and begins PID control with the correct tuning parameters. This works with any process, including integrating type processes, and allows retuning at a fixed setpoint.

4.10.1 Tune for Simplex Outputs

After “TUNE” has been enabled, you can start Accutune as shown in Table 4-10.

Table 4-10 Procedure for Starting “TUNE”

Step	Operation	Press	Result
1	Configure LSP1		Until SP (Local Setpoint 1) shows in the lower display.
2		 or 	Until LSP1 is to the desired value.
3	Switch to “Automatic” Mode		Until the “A” indicator is lighted (on controllers with Manual option).

4	Show Tuning Prompt		Until "TUNE OFF" is shown on lower display.
5	Initiate Tuning		Select "DO SLOW" or "DO FAST" in lower display.
6	Tuning in operation		Upper display will show a "T" as long as ACCUTUNE process is operating. When process completes, tuning parameters are calculated and lower display will show "NO TUNE" prompt.

ATTENTION

The Accutune process may be aborted at any time by changing the lower display back to "NoTUNE" or by switching the controller into Manual Mode.

4.10.2 Tune for Duplex (Heat/Cool)

Accutune for applications using Duplex (Heat/Cool) control.

The controller must be configured to have two local setpoints unless Blended Tuning is desired (see below). See *Subsection 3.11- Control Set Up Group* for details on configuring two local setpoints. During tuning, the Accutune III process assumes that Local Setpoint 1 will cause a Heating demand (output above 50%), and the tuning parameters calculated for that setpoint are automatically entered as PID SET 1. Likewise, Accutune III assumes that Local Setpoint 2 will cause a Cooling demand (output less than 50%), and the tuning parameters calculated for that setpoint are automatically entered as PID SET 2.

Configuration Check for Duplex

See *Subsection 3.6 - Accutune Set Up Group* for details.











Make sure:

- TUNE has been enabled
- DUPLEX has been configured to Manual, Automatic or Disabled

4.10.3 Using AUTOMATIC TUNE at start-up for Duplex (Heat/Cool)

Used when DUPLEX has been configured for AUTOMATIC. This is the preferred selection for most Heat/Cool applications when tuning a new chamber. This selection will sequentially perform both Heat and Cool tuning without further operator intervention.

Table 4-11 Procedure for Using AUTOMATIC TUNE at Start-up for Duplex Control







Step	Operation	Press	Result
1	Configure LSP1		Until SP (Local Setpoint 1) shows in the lower display.
2		 or 	Until LSP1 is a value within the Heat Zone (output above 50%).
3	Configure LSP2		Until 2SP (Local Setpoint 2) shows in the lower display.
4		 or 	Until LSP2 is a value within the Cool Zone (output below 50%).
5	Switch to "Automatic" Mode		Until the "A" indicator is lighted (on controllers with Manual option).
6	Show Tuning Prompt		Until "TUNE OFF" is shown on lower display.
7	Initiate Tuning		Select "DO SLOW" or "DO FAST" in lower display.
	Tuning in operation		Upper display will show a "T" as long as ACCUTUNE process is operating. When process completes, tuning parameters are calculated and lower display will show "NO TUNE" prompt.

4.10.4 Using BLENDED TUNE at start-up for Duplex (Heat/Cool)

When DUPLEX has been configured for DISABLE. This is the preferred selection for Heat/Cool applications which use a highly insulated chamber (a chamber which will lose heat very slowly unless a cooling device is applied). Only one local setpoint (LSP 1) is needed for this selection.

This selection results in performance tuning over the full range utilizing both Heat and Cool outputs to acquire blended tune values that are then applied to both Heat and Cool tuning parameters. Both PID sets are set to the same values.



Table 4-12 Procedure for Using BLENDED TUNE at Start-up for Duplex Control

Step	Operation	Press	Result
1	Configure LSP1		Until SP (Local Setpoint 1) shows in the lower display.
2		 or 	Until the Setpoint is to the desired value.
3	Switch to "Automatic" Mode		Until the "A" indicator is lighted (on controllers with Manual option).
4	Show Tuning Prompt		Until "TUNE OFF" is shown on lower display.
5	Initiate Tuning		Select "DO SLOW" or "DO FAST" in lower display.
6	Tuning in operation		Upper display will show a "T" as long as ACCUTUNE process is operating. When process completes, tuning parameters are calculated and lower display will show "NO TUNE" prompt.

4.10.5 Using MANUAL TUNE at start-up for Duplex (Heat/Cool)

When DUPLEX has been configured for MANUAL. This selection should be used when tuning is needed only for the HEAT zone or only for the COOL zone but not both. If Local Setpoint 1 is used, then the controller will perform a HEAT zone tune. If Local Setpoint 2 is used, then the controller will perform a COOL zone tune.

Table 4-13 Procedure for Using MANUAL TUNE for Heat side of Duplex Control

Step	Operation	Press	Result
1	Configure LSP1		Until SP (Local Setpoint 1) shows in the lower display.
2		 or 	Until LSP1 is a value within the Heat Zone (output above 50%).











Step	Operation	Press	Result
3	Switch to "Automatic" Mode		Until the "A" indicator is lighted (on controllers with Manual option).
4	Show Tuning Prompt		Until "TUNE OFF" is shown on lower display.
5	Initiate Tuning		Select "DO SLOW" or "DO FAST" in lower display.
6	Tuning in operation		Upper display will show a "T" as long as ACCUTUNE process is operating. When process completes, tuning parameters are calculated and lower display will show "NO TUNE" prompt.

Table 4-14 Procedure for Using MANUAL TUNE for Cool side of Duplex Control

Step	Operation	Press	Result
1	Configure LSP2		Until 2SP (Local Setpoint 2) shows in the lower display.
2		 or 	Until LSP2 is a value within the Cool Zone (output below 50%).
3	Switch to "Automatic" Mode		Until the "A" indicator is lighted (on controllers with Manual option).
4	Show Tuning Prompt		Until "TUNE OFF" is shown on lower display.
5	Initiate Tuning		Select "DO SLOW" or "DO FAST" in lower display.
6	Tuning in operation		Upper display will show a "T" as long as ACCUTUNE process is operating. When process completes, tuning parameters are calculated and lower display will show "NO TUNE" prompt.

4.10.6 Error Codes

Table 4-15 Procedure for Accessing Accutune Error Codes



Step	Operation	Press	Result
1	Select Accutune Set-up Group		Upper Display = SETUP Lower Display = ACCUTUNE
2	Go to Error Code Prompt		Upper Display = (an error code) Lower Display = AT ERROR Table 4-16 lists all the error codes, definitions, and fixes.

Table 4-16 Accutune Error Codes

Error Code (Upper Display)	Definition	Fix
RUNNING	ACCUTUNE RUNNING	The Accutune process is still active (Read Only)
NONE	NO ERRORS OCCURRED DURING LAST ACCUTUNE PROCEDURE	None
ID FAIL	PROCESS IDENTIFICATION FAILURE Autotune has aborted because an illegal value of GAIN, RATE, or reset was calculated.	<ul style="list-style-type: none"> Illegal Values – try Accutune again. untunable process -- contact local application engineer.
ABORT	CURRENT ACCUTUNE PROCESS ABORTED caused by the following conditions: <i>a. Operator changed to Manual mode</i> <i>b. Digital Input detected</i> <i>c. In Heat region of output and a Cool output calculated or vice versa.</i>	Try Accutune again
SP2	LSP2 not enabled or LSP1 or LSP2 not in use (only applies to Duplex Tuning)	Enable LSP2 and configure the desired LSP1 and LSP2 setpoints. See <i>Section 4.10</i> .

Aborting Accutune

To abort Accutune and return to the last previous operation (SP or output level), press **MAN-AUTO** key to abort the Accutune process or increment from the “DO SLOW” or “DO FAST” prompt to the “TUNE OFF” prompt.

Completing Accutune

When Accutune is complete, the calculated tuning parameters are stored in their proper memory location and can be viewed in the TUNING Set up Group, and the controller will control at the local setpoint using these newly calculated tuning constants.

4.11 Fuzzy Overshoot Suppression

Introduction

Fuzzy Overshoot Suppression minimizes Process Variable overshoot following a setpoint change or a process disturbance. This is especially useful in processes which experience load changes or where even a small overshoot beyond the setpoint may result in damage or lost product.

How it works

The Fuzzy Logic in the controller observes the speed and direction of the PV signal as it approaches the setpoint and temporarily modifies the internal controller response action as necessary to avoid an overshoot. There is no change to the PID algorithm, and the fuzzy logic does not alter the PID tuning parameters. This feature can be independently Enabled or Disabled as required by the application to work with the Accutune algorithm. Fuzzy Tune should not be enabled for processes that have an appreciable amount of deadtime.

Configuration

To configure this item, refer to Section 3 - Configuration:

Set Up Group “**ACCUTUNE**”

Function Prompt “**FUZZY**”

Select “**ENABLE**” or “**DISABLE**” - Use ▲ or ▼.

4.12 Using Two Sets of Tuning Constants

Introduction

You can use two sets of tuning constants for single output types and choose the way they are to be switched. (this does not apply for Duplex control, which always uses two PID sets).

The sets can be:







- keyboard selected,
- automatically switched when a predetermined process variable value is reached,
- automatically switched when a predetermined setpoint value is reached.

Set up Procedure

The following procedure (Table 4-17) to:





- select two sets,
- set the switch-over value,
- set tuning constant value for each set.

Table 4-17 Set Up Procedure

Step	Operation	Press	Result
1	Select Control Set-up Group		Until you see: <i>Upper Display</i> = SET <i>Lower Display</i> = CONTRL
2	Select PID SETS		Until you see: <i>Upper Display</i> = (available selections) <i>Lower Display</i> = PID SETS
3	Select PID SETS Function	 or 	To select the type of function. Available selections are: 1 ONLY —1 set of constants 2KEYBD —2 sets, keyboard selectable 2PV SW —2 sets, auto switch at PV value 2SP SW —2 sets, auto switch at SP value
4	Set Tuning Values for Each Set		Refer to “TUNING” Set up group, subsection 3.4 and set the following tuning parameters: PB or GAIN * RATE MIN * RSET MIN or RSET RPM * CYC SEC or CYC SX3 * PB2 or GAIN2 ** RATE2MIN ** RSET2MIN or RSET2RPM ** CYC2SEC or CYC2SX3 ** *PIDSET1 will be used when PV or SP, whichever is selected, is greater than the switchover value. **PIDSET2 will be used when PV or SP, whichever is selected, is less than the switchover value.
5	Set Switchover Value for 2 PVS W or 2 SPS W Selection	  or 	Until you see: <i>Upper Display</i> = (the switchover value) <i>Lower Display</i> = SW VAL To select the switchover value in the upper display.

Switch between two sets via keyboard (without automatic switch-over)

Table 4-18 Procedure for Switching PID SETS from the Keyboard

Step	Operation	Press	Result
1	Select Control Set-up Group		Until you see: <i>Upper Display = (the PV value)</i> <i>Lower Display = PIDS X (X= 1 or 2)</i>
2		 or 	To change PID SET 1 to PID SET2 or Vice Versa. You can use Accutune on each set.
3			To accept changes.

4.13 Alarm Setpoints

Introduction

An alarm consists of a relay contact and an operator interface indication. The alarm relay is de-energized if setpoint 1 or setpoint 2 is exceeded.





The alarm relay is energized when the monitored value goes into the allowed region by more than the hysteresis.

The relay contacts can be wired for normally open (NO) energized or normally closed (NC) de-energized using internal jumper placement. See Table 2-3 in the *Section 2 – Installation* for alarm relay contact information.

There are four alarm setpoints, two for each alarm. The type and state (High or Low) is selected during configuration. See *Subsection 3.13 – Configuration* for details.

Alarm Setpoints Display

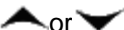
Table 4-19 Procedure for Displaying Alarm Setpoints

Step	Operation	Press	Result
1	Select Alarm Set-up Group		Until you see: <i>Upper Display = SET</i> <i>Lower Display = ALARMS</i>
2	Access the Alarm Setpoint Values		To successively display the alarm setpoints and their values. Their order of appearance is shown below. <i>Upper Display = (the alarm setpoint value)</i> <i>Range values are within the range of the selected parameters except:</i> DEVIATION (DEV) value = PV Span EVENTS (EV-ON/EV-OFF) value = Event Segment Number PV RATE OF CHANGE (PVRATE) = The amount of PV change in one minute in engineering units. LOOP BREAK ALARMS (BREAK) = The timer value may be changed only for controllers configured for ON/OFF control. <i>Lower Display = A1S1 VAL = Alarm 1, Setpoint 1 Value</i> <i>A1S2 VAL = Alarm 1, Setpoint 2 Value</i> <i>A2S1 VAL = Alarm 2, Setpoint 1 Value</i> <i>A2S2 VAL = Alarm 2, Setpoint 2 Value</i> NOTES: <i>With Three position step control, alarms set for "output" will not function.</i> <i>MANUAL, RSP, and F'SAFE selections do not have setpoint values.</i>
3	Change a value		To change any alarm setpoint value in the upper display.
4	Return to Normal Display		

4.14 Three Position Step Control Algorithm

Introduction

The Three Position Step Control algorithm allows the control of a valve (or other actuator) with an electric motor driven by two controller output relays; one to move the motor upscale, the other to move it downscale, without a feedback slidewire linked to the motor shaft.

Estimated Motor Position

The Three Position Step control algorithm provides an output display which is an estimated motor position since there is no slidewire feedback.

- Although this output indication is only accurate to a few percent, it is corrected each time the controller drives the motor to one of its stops (0 % or 100 %).
- It avoids all the control problems associated with the feedback slidewire (wear, dirt, and noise).
- When operating in this algorithm, the output display is shown to the nearest percent (that is, no decimal).

See Motor Travel Time (the time it takes the motor to travel from 0 % to 100 %) in section 3.8.

Motor Position Display

Table 4-20 Procedure for Displaying 3Pstep Motor Position

Step	Operation	Press	Result
1	Access the Displays		Until you see: <i>Upper Display = PV</i> <i>Lower Display = OT (The estimated motor position in %)</i>





4.15 Setting a Failsafe Output Value for Restart After a Power Loss

Introduction

If the power to the controller fails and power is reapplied, the controller goes through the power up tests, then goes to a user configured FAILSAFE OUTPUT VALUE.

Set a Failsafe Value

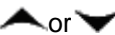
Table 4-21 Procedure for Setting a Failsafe Value

Step	Operation	Press	Result
1	Select Control Set-up Group		Until you see: <i>Upper Display = SET</i> <i>Lower Display = CONTROL</i>
2	Select Failsafe Function Prompt		You will see: <i>Upper Display = (range)</i> <i>within the range of the Output 0 to 100 for all output types except Three Position Step</i> Three Position Step <i>0 = motor goes to closed position</i> <i>100 = motor goes to open position</i> <i>Lower Display = F'SAFE</i>
3	Select a value		To select a failsafe output value in the upper display
4	Return to Normal Display		At power up, the output will go to the value set.





4.16 Setting Failsafe Mode

Introduction

You can set the Failsafe Mode to be Latching or Non-Latching.

Set Failsafe Mode

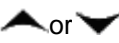
Table 4-22 Procedure for Setting a Failsafe Mode

Step	Operation	Press	Result
1	Select Control Set-up Group		Until you see: <i>Upper Display</i> = SET <i>Lower Display</i> = CONTROL
2	Select Failsafe Function Prompt		You will see: <i>Upper Display</i> = LATCH (Controller goes to manual and output goes to failsafe value) NoLATCH (Controller mode does not change and output goes to failsafe value) <i>Lower Display</i> = FSMODE
3	Select a value		To select a failsafe mode in the upper display.
4	Return to Normal Display		At power up, the output will go to the value set.

4.17 Setpoint Rate/Ramp/Program Overview

Introduction

The Setpoint Ramp configuration group lets you enable and configure any of the following:

- **SP RATE** – a specific rate of change for any local setpoint change. (Subsection 4.18)
- **SP RAMP** – a single setpoint ramp that occurs between the current local setpoint and a final local setpoint over a time interval of 1 to 255 minutes. (Subsection 4.19)
- **SP PROG** – a ramp/soak profile in a 12-segment program. (Subsection 4.20)

This section explains the operation of each selection and configuration reference where necessary.

PV Hot Start

This is a standard feature. At power-up, the setpoint is set to the current PV value and the Rate or Ramp or Program then starts from this value.

RUN/HOLD key

You can start or stop the Ramp or Program using the RUN/HOLD key.

4.18 Setpoint Rate

Introduction

When you have configured a SETPOINT RATE, it will apply immediately to local setpoint change.

Configuration check

Make sure:

- SPRATE is enabled
- A Rate Up (EUHRUP) or Rate Down (EUHRDN) value has been configured in Engineering units per hour.

ATTENTION

A value of 0 will imply an immediate change in setpoint, that is, NO RATE applies. See *Subsection 3.5 – Configuration group “SPRAMP” for details.*

Operation

When a change to local setpoint is made, this controller will ramp from the original setpoint to the “target” setpoint at the rate specified.

The current setpoint value is shown as **SPn XXXX** on the lower display while the “target” setpoint is shown as **SP XXXX** on the lower display.

Power outages

If power is lost before the “target” setpoint is reached, upon power recovery, the controller powers up with $S_n = \text{Current PV value}$ and it automatically “Restarts” from $S_n = \text{current PV value}$ up to the original “target” setpoint.

4.19 Setpoint Ramp

Introduction

When you have configured a SETPOINT RAMP, the ramp will occur between the current local setpoint and a final local setpoint over a time interval of from 1 to 255 minutes. You can RUN or HOLD the ramp at any time.

Configuration Check

Make sure





- SPRAMP is enabled
- SP RATE and SPPROG are not running.

- A Ramp Time (TIMIN) in minutes has been configured
- A final setpoint value (FINLSP) has been configured. See Subsection 3.5 – Configuration group “SPRAMP” for details.

Operation

Running a Setpoint Ramp includes starting, holding, viewing the ramp, ending the ramp and disabling it. See Table 4-23.

Table 4-23 Running A Setpoint Ramp

Step	Operation	Press	Result
1	Select Automatic Mode		“A” indicator is on. <i>Upper Display</i> = “H” and PV value <i>Lower Display</i> = SP and Present value
2	Set Start Setpoint		Until start SP value is in lower display <i>Upper Display</i> = “H” and PV value <i>Lower Display</i> = SP and start SP value
3	Start the Ramp		You will see <i>Upper Display</i> = “R” and a changing PV value <i>Lower Display</i> = SP and a changing SP value increasing or decreasing toward the final SP value
4	Hold/Run the Ramp		This holds the ramp at the current setpoint value. Press again to continue.
5	View the remaining ramp time		Until you see <i>Upper Display</i> = PV value <i>Lower Display</i> = RAMPXXXM (time remaining in minutes)
6	End the Ramp		When the final setpoint is reached, “R” changes to “H” in the upper display and the controller operates at the new final setpoint.
7	Disable SPRAMP		See Section 3 – Configuration group “SPRAMP” for details.

Power Outage

If power is lost during a ramp, upon power-up the controller will be in HOLD and the setpoint value will be the setpoint value prior to the beginning of the setpoint ramp.

The ramp is placed in hold at the beginning.

Configure the mode at Set Up Group “CONTROL”, function prompt “PWR MODE”. See Subsection 3.11 – CONTROL SETUP GROUP Prompts.

4.20 Setpoint Ramp/Soak Programming

Introduction

The term “programming” is used here to identify the process for selecting and entering the individual ramp and soak segment data needed to generate the required setpoint versus time profile (also called a program).

A segment is a ramp or soak function which together make up a setpoint program. Setpoint Ramp/Soak Programming lets you configure six ramp and six soak segments to be stored for use as one program or several small programs. You designate the beginning and end segments to determine where the program is to start and stop.

Review program data and configuration

While the procedure for programming is straightforward, and aided by prompts, we suggest you read “Program Contents”. Table 4-24 lists the program contents and an explanation of each to aid you in configuration. Then refer to Subsection 3.5–Configuration to do the setpoint program.

Make sure SPRAMP is disabled.

Fill out the worksheet

Refer to the example in Figure 4-3 and draw a Ramp/Soak Profile on the worksheet provided (Figure 4-4) and fill in the information for each segment. This will give you a record of how the program was developed.

Operation

Refer to Table 4-25 Run/Monitor the program.

Program Contents

Table 4-24 lists all the program contents and a description of each.

Table 4-24 Program Contents

Associated Prompts	Contents	Definition
STRT SEG	Start segment number	The start segment number designates the number of the first segment. Range = 1 to 11
END SEG	End segment number	The end segment number designates the number of the last segment, it must be a soak segment (even number). Range = 2 to 12
RECYCLES	Recycle number	The recycle number allows the program to recycle a specified number of times from beginning to end. Range = 0 to 99
STATE	Program state	The program state selection determines the program state after completion. The selections are: <ul style="list-style-type: none"> • DISABLE = program is disabled (so program value changed to DISABLE) • HOLD = program on hold
PROG END	Program termination state	The program termination state function determines the status of the controller upon completion of the program. The selections are: <ul style="list-style-type: none"> • LAST = controls to last setpoint • FAILSAFE = manual mode and failsafe output.
KEYRESET (ToBEGIN)	Reset Program to Beginning	When enabled, this selection allows you to reset the program via the keyboard to the beginning of the program.
KEYRESET (RERUN)	Rerun current segment	When enabled, this selection allows you to reset the program via the keyboard to the beginning of the current segment.
HOTSTART	Hot Start	This function determines whether LSP1 or PV is used as the setpoint when the program is initially changed from HOLD to RUN. The selections are: <p>DISABLE = When the program is initially changed from HOLD to RUN the present LSP1 value is captured as the default setpoint. If the program is terminated or the power cycled before the program has completed, the LSP1 is used as the control setpoint. The beginning segment uses this value as the initial ramp setpoint.</p> <p>ENABLE = When the program is initially changed from HOLD to RUN the present PV value is captured and used as the beginning setpoint value for the ramp segment. If the program is terminated before completion, the setpoint value will revert back to the PV value captured at the initial HOLD to RUN transition. If the power is cycled before program completion, upon power-up the setpoint is set to</p>

Associated Prompts	Contents	Definition
<p>RAMPUNIT SEGxRAMP or SEGxRATE</p>	<p>Ramp time or rate segments</p>	<p>the PV value at power-up and when the program is restarted that setpoint value is used initially.</p> <p>A ramp segment is the time it will take to change the setpoint to the next setpoint value in the program.</p> <p>Ramps are odd number segments (1, 3, . . . 11). Segment #1 will be the initial ramp time.</p> <p>Ramp time is determined in either:</p> <p style="padding-left: 40px;">TIME* - Hours.Minutes Range = 0-99hr.59 min.</p> <p style="padding-left: 80px;">or</p> <p style="padding-left: 40px;">RATE* - EU/MIN or EU/HR Range = 0 to 999</p> <p>* This selection of time or rate is made at prompt "RAMPUNIT".</p> <p>Set this prompt before entering any Ramp values.</p> <p>ATTENTION Entering "0" implies an immediate step change in setpoint to the next soak.</p>
<p>SEGx SP SEGxTIME</p>	<p>Soak segments</p>	<p>A soak segment is a combination of soak setpoint (value) and a soak duration (time).</p> <ul style="list-style-type: none"> • Soaks are even number segments (2, 4, . . . 12). • Segment 2 will be the initial soak value and soak time. • The soak setpoint range value must be within the setpoint high and low range limits in engineering units. • Soak time is the duration of the soak and is determined in: <p style="padding-left: 40px;">TIME - Hours:Minutes Range = 0-99 hr:59 min.</p>
<p>SOAK DEV</p>	<p>Guaranteed soak</p>	<p>All soak segments can have a deviation value of from 0 to ± 99 (specified by SOK DEV) which guarantees the deviation value for that segment.</p> <p>Guaranteed soak deviation values greater than zero guarantee that the soak segment's process variable is within the ± deviation value for the configured soak time. Whenever the ± deviation value is exceeded, the soak timer stops until the process variable gets within the ± deviation value.</p> <p>There are no guaranteed soaks whenever the deviation value is configured to 0, (that is, soak segments start timing soak duration as soon as the soak setpoint is first reached, regardless of where the process variable remains relative to the soak segment).</p> <p>The soak deviation value is the number in engineering units, above or below the setpoint, outside of which the timer halts. The range is 0 to ± 99.XX.</p> <p>The decimal location here corresponds decimal configuration chosen in the Display Set up group.</p>

Ramp/soak profile example

Before you perform the actual configuration, we recommend that you draw a Ramp/Soak profile in the space provided on the “*Program Record Sheet*” (Figure 4-4) and fill in the associated information. An example of a Ramp-Soak Profile is shown in Figure 4-3. Start setpoint is at 200 degrees F.

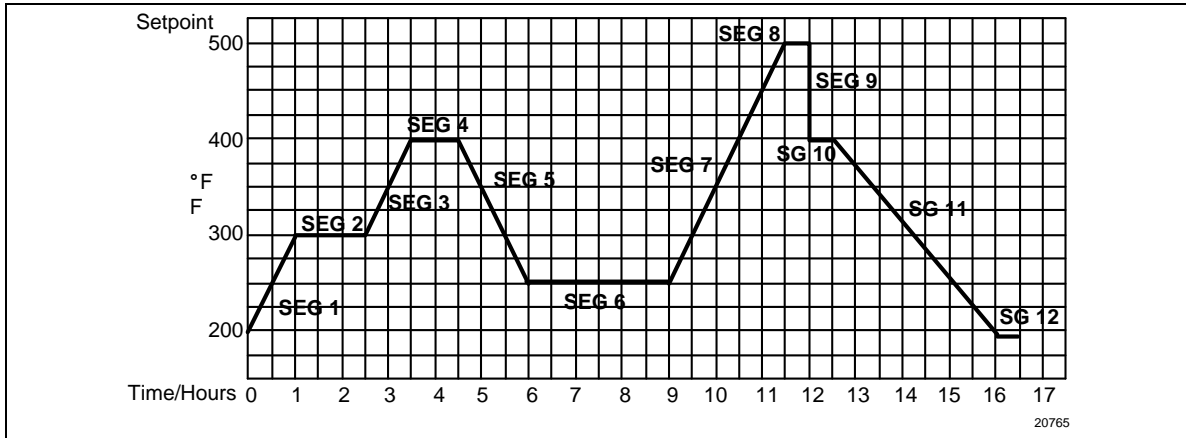

Figure 4-3 Ramp/Soak Profile Example

Ramp/Soak Profile Example

Prompt	Function	Segment	Value
STRT SEG	Start Seg.		1
END SEG	End Seg.		12
RAMP UNIT	Engr. Unit for Ramp		TIME
RECYCLES	Number of Recycles		2
SOAK DEV	Deviation Value		0
PROG END	Controller Status		LAST SP
STATE	Controller State at end		HOLD
KEYRESET	Reset SP Program		DISABLE
HOTSTART	PV Hot Start Program Initialization or power up in SPP		DISABLE
SEG1RAMP	Ramp Time	1	1 hr.
SEG2 SP	Soak SP	2	300
SEG2TIME	Soak Time	2	1 hr:30 min.
SEG3RAMP	Ramp Time	3	1 hr.
SEG4 SP	Soak SP	4	400
SEG4TIME	Soak Time	4	1 hr.
SEG5RAMP	Ramp Time	5	1 hr:30 min.
SEG6 SP	Soak SP	6	250
SEG6TIME	Soak Time	6	3 hr:0 min.
SEG7RAMP	Ramp Time	7	2 hr:30 min.
SEG8 SP	Soak SP	8	500
SEG8TIME	Soak Time	8	0 hr:30 min.
SEG9RAMP	Ramp Time	9	0
SG10 SP	Soak SP	10	400
SG10 TIME	Soak Time	10	0 hr:30 min.
SG11RAMP	Ramp Time	11	3 hr:30 min.
SG12 SP	Soak SP	12	200
SG12TIME	Soak Time	12	0 hr:30 min.

Program record sheet

Draw your ramp/soak profile on the record sheet shown in Figure 4-4 and fill in the associated information in the blocks provided. This will give you a permanent record of your program and will assist you when entering the Setpoint data.

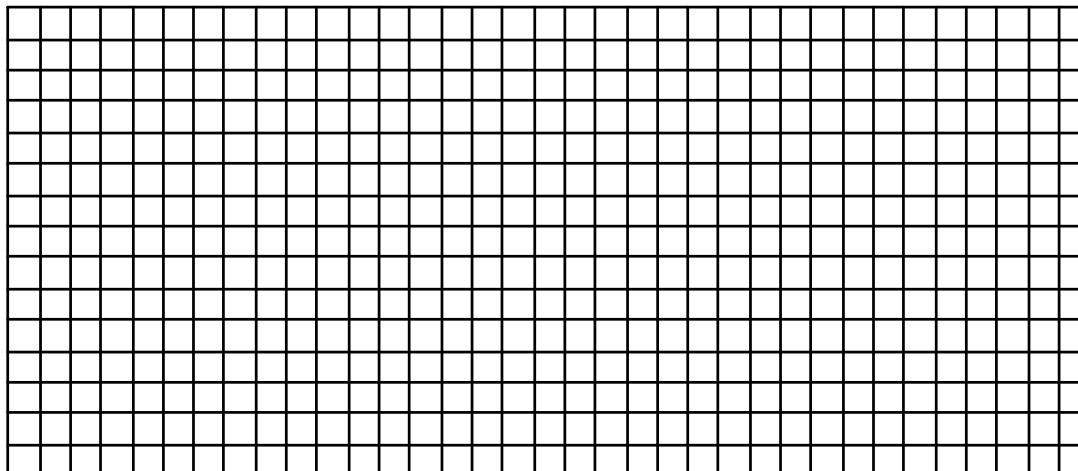

20766

Figure 4-4 Program Record Sheet

Prompt	Function	Segment	Value	Prompt	Function	Segment	Value
STRT SEG	Start Seg.			SEG4TIME	Soak Time	4	
END SEG	End Seg.			SEG5RAMP	Ramp Time	5	
RAMPUNIT	Engr. Unit for Ramp			SEG6 SP	Soak SP	6	
RECYCLES	Number of Recycles			SEG6TIME	Soak Time	6	
SOAK DEV	Deviation Value			SEG7RAMP	Ramp Time	7	
PROG END	Controller Status			SEG8 SP	Soak SP	8	
STATE	Controller State at end			SEG8TIME	Soak Time	8	
KEYRESET	Reset SP Program			SEG9RAMP	Ramp Time	9	
HOT START	PV Hot Start Program Initialization or power up in SPP			SG10 SP	Soak SP	10	
SEG1RAMP	Ramp Time	1		SG10 TIME	Soak Time	10	
SEG2 SP	Soak SP	2		SG11RAMP	Ramp Time	11	
SEG2TIME	Soak Time	2		SG12 SP	Soak SP	12	
SEG3RAMP	Ramp Time	3		SG12TIME	Soak Time	12	
SEG4 SP	Soak SP	4					

Run/Monitor the program

Prior to running the program, make sure all the “SP PROG” function prompts under the Set Up group “SP RAMP” have been configured with the required data.





“H” appears in the upper display indicating that the program is in the HOLD state.

ATTENTION SP Program parameter *cannot* be changed during RUN state; the unit must be in the HOLD state in order to change parameters.

Run/Monitor functions

Table 4-25 lists all the functions required to run and monitor the program.

Table 4-25 Run/Monitor Functions

Function	Press	Result
Set the Local Setpoint		<i>Upper Display</i> = PV value <i>Lower Display</i> = SP
	or	
Run State		Initiates the setpoint program. “R” appears in the upper display indicating that the program is running.
Hold State		Holds the setpoint program. “H” appears in the upper display indicating that the program is in the HOLD state. The setpoint holds at the current setpoint.
External Hold		If one of the Digital Inputs is programmed for the HOLD function, then contact closure places the controller in the HOLD state, if the setpoint program is running. The upper display will periodically show “H” while the switch is closed. ATTENTION The keyboard takes priority over the external switch for the RUN/HOLD function. Reopening the HOLD switch runs the program.
Viewing the present ramp or soak segment number and time	 until you see	<i>Upper Display</i> = PV value <i>Lower Display</i> = XXRAHH.MM for Ramps or = XXSKHH.MM for Soaks Time remaining in the SEGMENT in hours and minutes. XX = The segment number, 1 to 12.

continued

Function	Press	Result
Viewing the number of cycles left in the program	 until you see	Upper Display = PV value Lower Display = RECYC XX Number of cycles remaining in the setpoint program. X = 0 to 99
End Program		When the final segment is completed, the “R” in the upper display either changes to “H” (if configured for HOLD state), or disappears (if configured for disable of setpoint programming). <ul style="list-style-type: none"> • The controller then either operates at the last setpoint in the program or goes into manual mode/failsafe output, depending upon the “LAST” configuration.
Disable Program		See Section 3 – Configuration Group “SP PROG” for details.

Power outage

ATTENTION If power is lost during a program, upon power-up the controller will be in hold and the setpoint value will be the setpoint value prior to the beginning of the setpoint program. The program is placed in hold at the beginning. The mode will be as configured under “PWR UP” in the “CONTROL” group.

Digital input (remote switch) operation

Program can be placed in RUN, HOLD, RERUN, or BEGIN state through a remote dry contact connected to optional digital input terminals, as follows:

RUN—contact closure places Program in RUN state, OR

HOLD—contact closure places Program in HOLD state

RERUN—contact closure allows the Setpoint Programmer to be reset to the initial segment of its current cycle, unit stays in previous mode.

Opening the contact will cause the Controller to revert to its original state.

BEGIN— Contact closure resets SP Program back to the beginning of the first segment in the program and places the program in the HOLD mode. Program cycle number is not affected. Reopening switch has no effect.

Opening the contact will cause the Controller to revert to its original state.

5 Input Calibration



WARNING—SHOCK HAZARD

INPUT CALIBRATION MAY REQUIRE ACCESS TO HAZARDOUS LIVE CIRCUITS, AND SHOULD ONLY BE PERFORMED BY QUALIFIED SERVICE PERSONNEL. MORE THAN ONE SWITCH MAY BE REQUIRED TO DE-ENERGIZE UNIT BEFORE CALIBRATION.

5.1 Overview

Introduction

This section describes the field calibration procedures for Input 1 and Input 2.

- All input actuations in every UDC3200 controller are fully factory-calibrated and are ready for configuration by the user.
- Field Calibration can improve the accuracy of the Controller if necessary for a particular application.

CAUTION

The field calibration will be lost if a change in input type configuration is implemented at a later time. The original factory calibration data remains available for later use after a field calibration is done. See subsection 5.6 if you want to restore factory calibration values.

What's in this section?

The following topics are covered in this section.

TOPIC	See Page
5.1 Overview	133
5.2 Minimum and Maximum Range Values	134
5.3 Preliminary Information	136
5.4 Input #1 or 2 Set Up Wiring	137
5.5 Input #1 or 2 Calibration Procedure	141
5.6 Restore Factory Calibration	142

Calibration Steps

Use the following steps when calibrating an input.

Step	Action
1	Find the minimum and maximum range values for your PV input range from Table 5-1.
2	Disconnect the field wiring and find out what equipment you will need to calibrate.
3	Wire the calibrating device to your controller according to the set up wiring instructions for your particular input (Subsection 5.4).
4	Follow the calibration procedure given for Input #1 or Input #2 (Subsection 5.5).

5.2 Minimum and Maximum Range Values

Select the Range Values

Calibrate the controller for the minimum (0 %) and maximum (100 %) range values of your particular input type. Two input controllers will need to have each input calibrated separately.

Select the Voltage, Current or Resistance equivalents for 0 % and 100 % range values from Table 5-1. Use these values when calibrating your controller.

Table 5-1 Voltage, Milliamp and Resistance Equivalents for Input Range Values

Sensor Type	PV Input Range		Range Values	
	°F	°C	0 %	100 %
Thermocouples (per ITS-90)				
B	0 to 3300	-18 to 1816	-0.100 mV	13.769 mV
E T C H	-454 to 1832	-270 to 1000	-9.835 mV	76.373 mV
E T C L	-200 to 1100	-129 to 593	-6.472 mV	44.455 mV
J T C H	0 to 1600	-18 to 871	-0.886 mV	50.060 mV
J T C M	20 to 900	-7 to 482	-0.334 mV	26.400 mV
J T C L	20 to 550	-7 to 288	-0.334 mV	15.650 mV
K T C H	0 to 2400	-18 to 1316	-0.692 mV	52.952 mV
K T C M	-20 to 1200	-29 to 649	-1.114 mV	26.978 mV
K T C L	-20 to 750	-29 to 399	-1.114 mV	16.350 mV
NNM H	32 to 2500	0 to 1371	0.000 mV	71.773 mV
NNM L	32 to 1260	0 to 682	0.000 mV	31.825 mV
NIC H	0 to 2372	-18 to 1300	-0.461 mV	47.513 mV
NIC L	0 to 1472	-18 to 800	-0.461 mV	28.455 mV
R T C	0 to 3100	-18 to 1704	-0.090 mV	20.281 mV

Sensor Type	PV Input Range		Range Values	
	°F	°C	0 %	100 %
S TC	0 to 3100	-18 to 1704	-0.092 mV	17.998 mV
T TC H	-300 to 700	-184 to 371	-5.341 mV	19.097 mV
T TC L	-200 to 500	-129 to 260	-4.149 mV	12.574 mV
W TC H	0 to 4200	-18 to 2315	-0.234 mV	37.075 mV
W TC L	0 to 2240	-18 to 1227	-0.234 mV	22.283 mV
Thermocouple Differential *	-50 to 150	-46 to 66	-1.54 mV	4.62 mV
Honeywell Radiamatic				
Type RH	0 to 3400	-18 to 1871	0.00 mV	57.12 mV
Type RI **	0 to 3400	-18 to 1871	0.00 mV	60.08 mV
RTD				
Alpha = 0.00385 per IEC-60751 (1995)				
100 ohms	-300 to 1200	-184 to 649	25.202 ohms	329.289 ohms
100 ohms (low)	-300 to 300	-184 to 149	25.202 ohms	156.910 ohms
200 ohms	-300 to 1200	-184 to 649	50.404 ohms	658.578 ohms
500 ohms	-300 to 1200	-184 to 649	126.012 ohms	1646.445 ohms
Linear				
Milliamps	4 to 20 mA 0 to 20 mA		4.00 mA 0.00 mA	20.00 mA 20.00 mA
Millivolts	0 to 10 mV 0 to 50 mV 0 to 100 mV		0.00 mV 0.00 mV 0.00 mV	10.00 mV 50.00 mV 100.00 mV
Volts	1 to 5 Volts 0 to 5 Volts 0 to 10 Volts		1.00 Volts 0.00 Volts 0.00 Volts	5.00 Volts 5.00 Volts 10.00 Volts
Carbon Oxygen	0 to 1250 mV -30 to 510 mV		0.00 mV -30.00 mV	1250.00 mV 510.00 mV

* The Factory Calibrated millivolt values for the Thermocouple Differential Input are for a pair of J thermocouples at an ambient temperature mean of 450°F / 232°C. Other thermocouple types and ambient temperature means may be accomplished via Field Calibration of the input, with the range value limits being -4 mV to +16 mV for the zero and span values.

** The range values for Radiamatic Type RI are customer configurable within the limits shown.

5.3 Preliminary Information

Disconnect the Field Wiring

Tag and disconnect any field wiring connected to the input (#1 or #2) terminals on the rear of the controller.

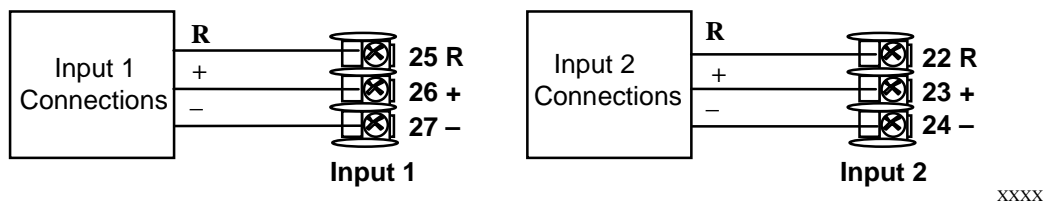

Figure 5-1 Input 1 and Input 2 Wiring Terminals

Equipment Needed

Table 5-2 lists the equipment you will need to calibrate the specific types of inputs that are listed in the table. You will need a screwdriver to connect these devices to your controller.

Table 5-2 Equipment Needed

Type of Input	Equipment Needed
Thermocouple Inputs (Ice Bath)	<ul style="list-style-type: none"> • A calibrating device with at least $\pm 0.02\%$ accuracy for use as a signal source such as a millivolt source. • Thermocouple extension wire that corresponds with the type of thermocouple that will be used with the controller input. • Two insulated copper leads for connecting the thermocouple extension wire from the ice baths to the mV source. • Two containers of crushed ice.
Thermocouple Inputs (T/C Source)	<ul style="list-style-type: none"> • A calibrating device with at least $\pm 0.02\%$ accuracy for use as a signal source such as a millivolt source. • Thermocouple extension wire that corresponds with the type of thermocouple that will be used with controller input.
RTD (Resistance Thermometer Device)	<ul style="list-style-type: none"> • A decade box, with at least $\pm 0.02\%$ accuracy, capable of providing stepped resistance values over a minimum range of 0 to 1650 ohms with a resolution of 0.001 ohm. • Three insulated copper leads of equal length for connecting the decade box to the controller.
Milliampere, Millivolt, Volts, and Radiamatic	<ul style="list-style-type: none"> • A calibrating device with at least $\pm 0.02\%$ accuracy for use as a signal source. • Two insulated copper leads for connecting the calibrator to the controller. • Place current source at zero before switching ON. • Do not switch current sources OFF/ON while connected to the UDC3200 input.

5.4 Input 1 or 2 Set Up Wiring

5.4.1 Thermocouple Inputs Using an Ice Bath

Refer to Figure 5-2 and wire the controller according to the procedure given in Table 5-3.

Table 5-3 Set Up Wiring Procedure for Thermocouple Inputs Using an Ice Bath

Step	Action
1	Connect the copper leads to the calibrator.
2	Connect a length of thermocouple extension wire to the end of each copper lead and insert the junction points into the ice bath.
3	Connect the thermocouple extension wires to the terminals for Input #1. See Figure 5-2.

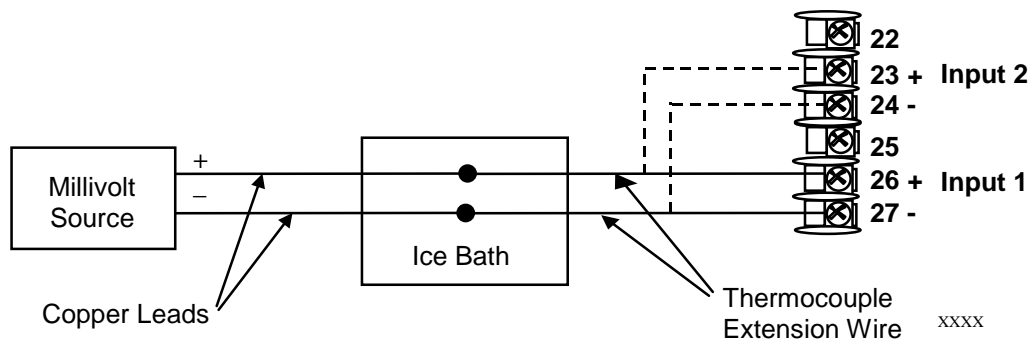

Figure 5-2 Wiring Connections for Thermocouple Inputs Using an Ice Bath

5.4.2 Thermocouple Inputs Using a Thermocouple Source

Refer to Figure 5-3 and wire the controller according to the procedure given in Table 5-4.

Table 5-4 Set Up Wiring Procedure for Thermocouple Inputs using Thermocouple Source

Step	Action
1	Connect the thermocouple extension wires to the terminals for Input #1 as shown in Figure 5-3.

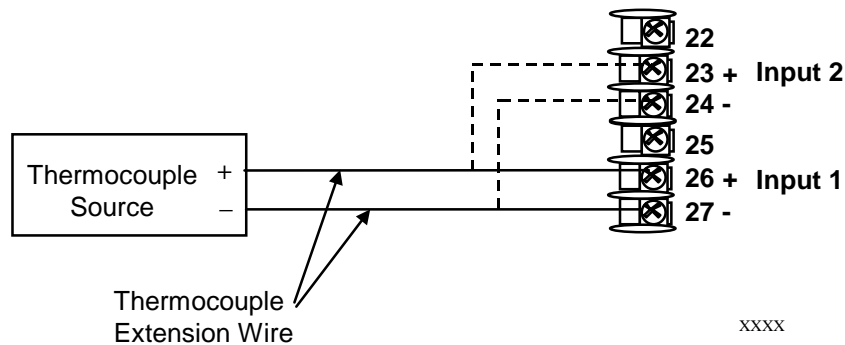

Figure 5-3 Wiring Connections for Thermocouple Inputs Using Thermocouple Source

5.4.3 RTD Inputs

Refer to Figure 5-4 and wire the controller according to the procedure given in Table 5-5.

Table 5-5 Set Up Wiring Procedure for RTD Inputs

Step	Action
1	Connect the copper leads from the calibrator to the Input #1 terminals as shown in Figure 5-4.

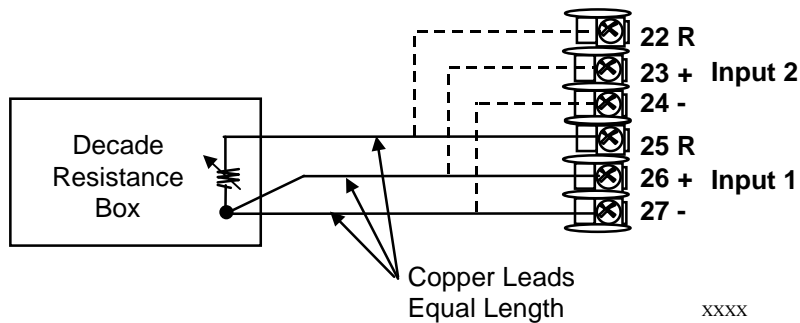

Figure 5-4 Wiring Connections for RTD (Resistance Thermometer Device)

5.4.4 Radiamatic, Millivolts, Volts or Thermocouple Differential Inputs

Refer to Figure 5-5 and wire the controller according to the procedure given in Table 5-6.

Table 5-6 Set Up Wiring Procedure for Radiamatic, Millivolts, Volts or Thermocouple Differential Inputs (Except 0-10 Volts)

Step	Action
1	Connect the copper leads from the calibrator to the Input #1 terminals as shown in Figure 5-5.
2	Place current/voltage source at zero before switching on.
3	Do not switch current/voltage source ON/OFF while connected to the instrument.

ATTENTION

For Radiamatic inputs only, set Emissivity value to 1.0.

See:

Subsection 3.9 – Configuration Set Up prompt INPUT 1, function prompt EMISSIV 1

Subsection 3.10 – Configuration Set Up prompt INPUT 2, function prompt EMISSIV 2

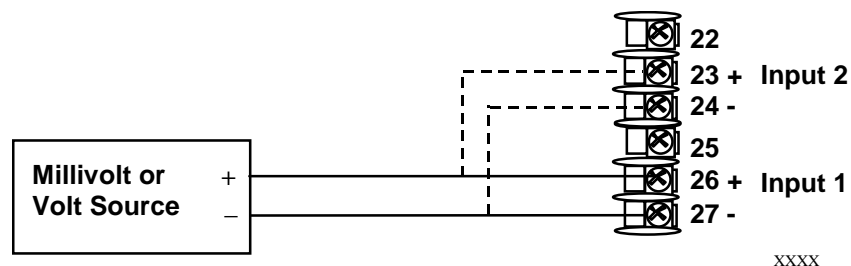

Figure 5-5 Wiring Connections for Radiamatic, Thermocouple Differential, Millivolts or Volts (Except 0 to 10 Volts)

5.4.5 0 to 10 Volts

Refer to Figure 5-6 and wire the controller according to the procedure given in Table 5-7.

Table 5-7 Set Up Wiring Procedure for 0 to 10 Volts

Step	Action
1	Connect the copper leads from the calibrator to the Input #1 terminals as shown in Figure 5-6.
2	Place voltage source at zero before switching on.
3	Do not switch voltage source ON/OFF while connected to the instrument.

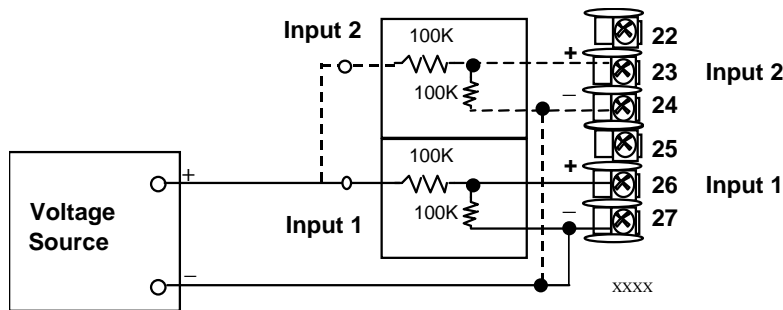

Figure 5-6 Wiring Connections for 0 to 10 Volts

5.4.6 Milliampere

Refer to Figure 5-5 and wire the controller according to the procedure given in Table 5-6.

Table 5-8 Set Up Wiring Procedure for Milliampere Inputs

Step	Action
1	Connect the copper leads from the calibrator to the Input #1 terminals as shown in Figure 5-7.
2	Place current source at zero before switching on.
3	Do not switch current source ON/OFF while connected to the instrument.

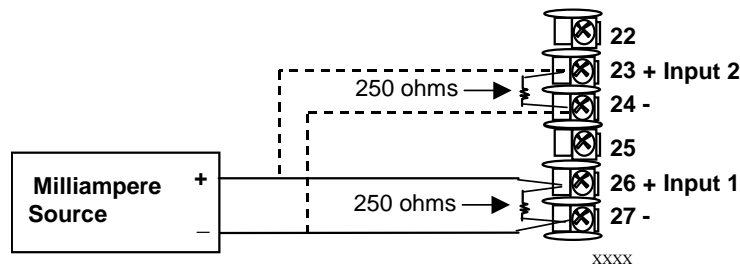

Figure 5-7 Wiring Connections for 0 to 20 mA or 4 to 20 mA Inputs

5.5 Input 1 or 2 Calibration Procedure

Preliminary Steps

- Apply power and allow the controller to warm up for 30 minutes before you calibrate.
- Please read *Subsection 5.4 – Input 1 or 2 Set Up Wiring* before beginning the procedure.
- **Make sure you have LOCK set to NONE.** See *Subsection 3.4 - Tuning Set Up Group*.
- See Table 5-1 for Voltage vs. Resistance equivalents or 0 % and 100 % range values.





CAUTION







For linear inputs, avoid step changes in inputs. Vary smoothly from initial value to final 100 % value.

Procedure

The calibration procedure for Input #1 or 2 is listed in Table 5-9.

Table 5-9 Input 1 or 2 Calibration Procedure

Step	Operation	Press	Result
1	Enter Calibration Mode	 until you see  or 	<i>Upper Display = CALIB</i> <i>Lower Display = INPUTn [n=1 or 2]</i> You will see: <i>Upper Display = DISABLE</i> <i>Lower Display = CAL INn [n=1 or 2]</i> The calibration sequence is enabled and you will see: <i>Upper Display = BEGIN</i> <i>Lower Display = CAL INn [n=1 or 2]</i> At the completion of the sequence, the selection automatically reverts to disable.
2	Calibrate 0 %		You will see: <i>Upper Display = APPLY</i> <i>Lower Display = INn ZERO [n=1 or 2]</i> <ul style="list-style-type: none"> • Adjust your calibration device to an output signal equal to the 0 % range value for your particular input sensor. See Table 5-1 for Voltage, Degrees, or Resistance equivalents for 0 % range values. • Wait 15 seconds, then go to the next step.

Step	Operation	Press	Result						
3	Calibrate 100 %		<p>You will see:</p> <p><i>Upper Display</i> = APPLY <i>Lower Display</i> = INn SPAN [n=1 or 2]</p> <ul style="list-style-type: none"> Adjust your calibration device to an output signal equal to the 100 % range value for your particular input sensor. See Table 5-1 for Voltage, Degrees, or Resistance equivalents for 100 % range values. Wait 15 seconds, and <table border="1" data-bbox="735 579 1430 741"> <thead> <tr> <th>If ...</th> <th>Then ...</th> </tr> </thead> <tbody> <tr> <td>you are calibrating a Thermocouple input</td> <td>go to step 4</td> </tr> <tr> <td>you are calibrating other than a Thermocouple input</td> <td>go to step 5</td> </tr> </tbody> </table>	If ...	Then ...	you are calibrating a Thermocouple input	go to step 4	you are calibrating other than a Thermocouple input	go to step 5
If ...	Then ...								
you are calibrating a Thermocouple input	go to step 4								
you are calibrating other than a Thermocouple input	go to step 5								
4	Check the Cold Junction Temperature		<p>The calculations for zero and span are now stored and you will see:</p> <p><i>Upper Display</i> = The cold junction temperature at the rear terminals <i>Lower Display</i> = CJTEMP</p> <p>The value in the upper display is in tenths of a degree. It is the current reading of the temperature as measured at the thermocouple terminals and recognized by the controller. You can change this value, if it is in error, using the  or  keys.</p> <p>WARNING: The accuracy of the controller is directly affected by the accuracy of this value. It is recommended that this value not be changed under normal circumstances.</p>						
5	Exit the Calibration Mode	 then 	<p>The controller stores the calibration constants and exits the calibration mode.</p>						

5.6 Restore Input Factory Calibration

Introduction

The factory calibration constants for all the input actuation types that can be used with the controller are stored in its non-volatile memory. Thus, you can quickly restore the “Factory Calibration” for a given input actuation type by simply changing the actuation type to another type and then changing it back to the original type.

Refer to Table 5-10 Restore Factory Calibration for procedure











ATTENTION

A restored factory calibration overwrites any previous field calibration done for the input and may change the High and Low Range Limits.

Protect your field calibration from accidental overwrites by configuring the appropriate LOCKOUT selection after calibration.

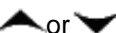
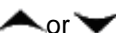
See *Section 3 - Configuration* for specific instructions to set the lockout.

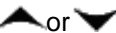
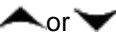
Table 5-10 Restore Factory Calibration

Step	Operation	Press	Result
1	Set LOCKOUT to NONE		until you see: <i>Upper Display</i> = SET UP <i>Lower Display</i> = TUNING
			Until you see: <i>Upper Display</i> = one of the following: NONE – all parameters are read/write CALIB – all parameters are read/write except Calibration +CONF – configuration parameters are Read Only; no writes permitted +VIEW – Tuning and Setpoint Ramp parameters are read/write. No other parameters can be viewed. ALL – Tuning and Setpoint Ramp parameters are available for read only. No other parameters can be viewed. <i>Lower Display</i> = LOCKOUT
2	Enter INPUT Setup Group	 or 	Until NONE is in the upper display
			until you see: <i>Upper Display</i> = SET UP <i>Lower Display</i> = INPUT n n = 1 or 2
			until you see: <i>Upper Display</i> = the current selection <i>Lower Display</i> = INn TYPE n = 1 or 2
3	Scroll through Functions	 or 	to change the current selection to another selection
			until the lower display rolls through the rest of the functions and returns to: <i>Upper Display</i> = the new selection <i>Lower Display</i> = INn TYPE n = 1 or 2
4	Return to Normal Operation	 or 	until you change the input selection in the upper display back to the proper selection. You will see: <i>Upper Display</i> = Original Input Selection that matches your type of sensor. <i>Lower Display</i> = INn TYPE n = 1 or 2
			to return to Normal operating mode. The factory calibration will be restored. If the problem is not corrected, contact the Honeywell Technical Assistance Center at 1-800-423-9883 USA and Canada

6 Output Calibration

6.1 Overview

Introduction

This section describes the field calibration procedures for the following types of outputs:

- Current Output
- Auxiliary Output
- Position Proportional Output and Three Position Step Output

What's in this section?

The following topics are covered in this section.

TOPIC	See Page
6.1 Overview	145
6.2 Current Output Calibration	146
6.3 Auxiliary Output Calibration	148
6.4 Position Proportional and Three Position Step Output Calibration	150
6.5 Restore Output Factory Calibration	153



WARNING—SHOCK HAZARD

OUTPUT CALIBRATION MAY REQUIRE ACCESS TO HAZARDOUS LIVE CIRCUITS, AND SHOULD ONLY BE PERFORMED BY QUALIFIED SERVICE PERSONNEL. MORE THAN ONE SWITCH MAY BE REQUIRED TO DE-ENERGIZE UNIT BEFORE CALIBRATION.

6.2 Current Output Calibration

Introduction

Calibrate the controller so that the output provides the proper amount of current over the desired range. The controller can provide an output current range of from 0 to 21 milliamperes and is usually calibrated at 4 mA for 0 % of output and 20 mA for 100 % of output, or any other values between 0 mA and 21 mA. It is not necessary to re-calibrate the controller in order to change from 4 to 20 mA operation over to 0 to 20 mA operation, a simple configuration change is all that is required. See the CO RANGE configuration in *Sub-section 3.8* for details.

Equipment Needed

You will need a standard shop type milliammeter, with whatever accuracy is required, capable of measuring 0 to 20 milliamps.

Calibrator Connections

Refer to Figure 6-1 and wire the controller according to the procedure given in Table 6-1.

Table 6-1 Set Up Wiring Procedure for Current Output

Step	Action
1	Apply power and allow the controller to warm up 30 minutes before you calibrate.
2	Set LOCK in the Tuning Set Up group to NONE.
3	Tag and disconnect the field wiring, at the rear of the controller, from terminals 21 (-) and 19 (+). See Figure 6-1.
4	Connect a milliammeter across these terminals.

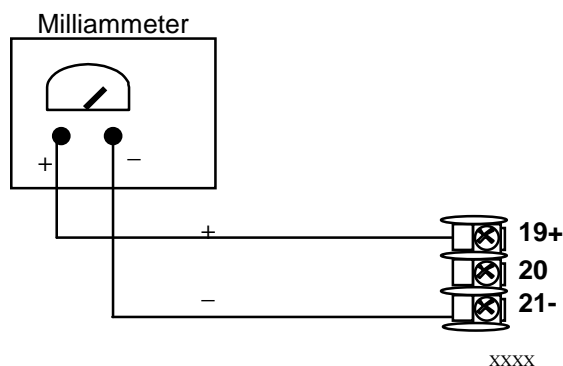











Figure 6-1 Wiring Connections for Calibrating Current Proportional Output

Procedure

The procedure for calibrating the Current Output is listed in Table 6-2. Make sure LOCK in the Tuning Set Up group is set to **NONE**. (See Subsection 3.4 – Tuning Set Up Group.)

Table 6-2 Current Output Calibration Procedure

Step	Operation	Press	Result
1	Enter Calibration Mode	 until you see	<i>Upper Display = CALIB</i> <i>Lower Display = CURRENT</i>
2	Calibrate 0 %	  or 	You will see: <i>Upper Display = A Value</i> <i>Lower Display = ZERO VAL</i> Until the desired 0 % output is read on the milliammeter, use the values shown below depending on the action of your controller. Normally, this will be the setting that produces 4 mA.
3	Calibrate 100 %	  or 	This stores the 0 % value and you will see: <i>Upper Display = A Value</i> <i>Lower Display = SPAN VAL</i> Until the desired 100 % output is read on the milliammeter, use the values shown below depending on the action of your controller. Normally, this will be the setting that produces 20 mA.
4	Exit the Calibration Mode	 	The controller stores the span value. To exit the calibration mode.

6.3 Auxiliary Output Calibration

Introduction

Calibrate the controller so that the auxiliary output provides the proper amount of current over the desired range. The controller can provide an auxiliary current output range of from 0 mA to 21 mA and is usually calibrated at 4 mA for 0 % of output and 20 mA for 100 % of output or any other values between 0 mA and 21 mA. It is not necessary to re-calibrate the controller in order to change from 4 to 20 mA operation over to 0 to 20 mA operation, a simple configuration change is all that is required. See the CO RANGE configuration in *Sub-section 3.12* for details.

Equipment Needed

You will need a calibrating device with whatever accuracy is required, capable of measuring 0 to 20 mA.

Calibrator Connections

Refer to Figure 6-2 and wire the controller according to the procedure given in Table 6-3.

Table 6-3 Set Up Wiring Procedure for Auxiliary Output

Step	Action
1	Apply power and allow the controller to warm up 30 minutes before you calibrate.
2	Set LOCK in the Tuning Set Up group to NONE.
3	Tag and disconnect the field wiring, at the rear of the controller, from terminals 12 (+) and 13 (-). See Figure 6-2.
4	Connect a milliammeter across these terminals.

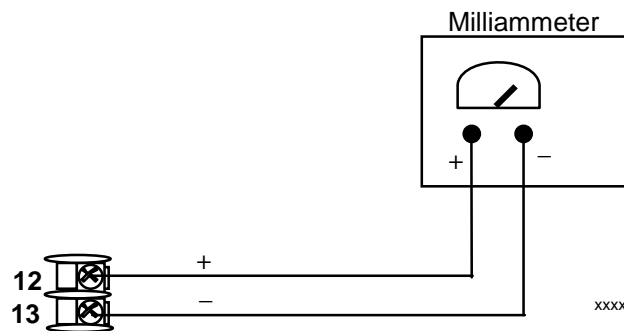



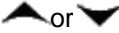
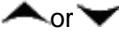

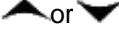
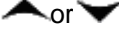

Figure 6-2 Wiring Connections for Calibrating Auxiliary Output

Procedure

The procedure for calibrating the auxiliary output is listed in Table 6-4.

Make sure “LOCK” in the Tuning Set Up group is set to “NONE” (see *Subsection 3.4*).

Table 6-4 Auxiliary Output Calibration Procedure

Step	Operation	Press	Result
1	Enter Calibration Mode	 until you see	<i>Upper Display</i> = CALIB <i>Lower Display</i> = AUX OUT
2	Calibrate 0 %	  or 	You will see: <i>Upper Display</i> = A Value <i>Lower Display</i> = ZERO VAL until the desired 0 % output is read on the milliammeter. Normally, this will be the setting that produces 4 mA.
3	Calibrate 100 %	  or 	To store the 0 % value you will see: <i>Upper Display</i> = A Value <i>Lower Display</i> = SPAN VAL until the desired 100 % output is read on the milliammeter. Normally, this will be the setting that produces 20 mA.
4	Exit the Calibration Mode	 	The controller stores the span value. To exit the calibration mode.

6.4 Position Proportional and Three Position Step Output Calibration

Position Proportional control

Position Proportional Control Output Models

This model must have its output calibrated per the entire procedure to ensure the displayed output (slidewire position) agrees with the final control element position.

Three position step control

Three Position Step Control Output Models not using slidewire feedback.

This model only requires that the “Motor Time” be entered as shown in *Subsection 3.8*.

Three Position Step Control Models using slidewire feedback.

This model must have its output calibrated per the entire procedure to ensure the displayed output (slidewire position) agrees with the final control element position.

Equipment needed

None.

Connections

Apply power and leave all field wiring connected to the rear terminals.

Procedure

The procedure for calibrating the Three Position Step control output is listed in Table 6-5. For Three Position Step Control (3Pstep), these prompts *only* appear when “SLIDEW” is selected in the INPUT 2 Setup group. For Position Proportional Control, the Output algorithm must also be configured for “POSITON”.









Make sure LOCKOUT in Tuning Set Up group is set to NONE. See *Subsection 3.4*.









ATTENTION For Three Position Step Control (3Pstep), these prompts *only* appear when “SLIDEW” is selected in the INPUT 2 Setup group. For Position Proportional Control, the Output algorithm must also be configured for “POSITON”. The Motor Time must be entered in the Output Algorithm Group for both Position Proportional or for 3Pstep control. See *Subsection 3.8* for details.

Table 6-5 Position Proportional and Three Position Step Output Calibration Procedure

Step	Description	Press	Action
1	Enter Calibration Mode		until you see <i>Upper Display = CALIB</i> <i>Lower Display = POS PROP</i>

continued

Step	Description	Press	Action						
2	Select Automatic or Manual Calibration		<p>until you see:</p> <p><i>Upper Display</i> = DISABLE <i>Lower Display</i> = POS PROP</p> <p>You can calibrate the controller output manually or let the controller calibrate the output automatically.</p> <p>If the slidewire has never been calibrated, you must use DO AUTO first. In the "Automatic Calibration Mode" (DO AUTO), the controller relays automatically move the motor in the proper direction.</p> <p>If desired, however, the motor may be manually positioned to 0 % and 100 % positions. Disconnect the relay wires. Use DO MAN. In the "Manual Calibration Mode" (DO MAN), the motor does not move. Instead, the existing 0 % and 100 % values may be changed with the  or  key.</p> <p> or  to select automatic or manual calibration.</p> <p><i>Upper Display</i> = DO AUTO or DO MAN <i>Lower Display</i> = POS PROP</p> <table border="1" data-bbox="863 926 1399 1031"> <thead> <tr> <th>If you select...</th> <th>Then...</th> </tr> </thead> <tbody> <tr> <td>DO AUTO</td> <td>go to Step 3</td> </tr> <tr> <td>DO MAN</td> <td>go to Step 5</td> </tr> </tbody> </table> <p>ATTENTION When calibration is terminated, this selection reverts to DISABL.</p>	If you select...	Then...	DO AUTO	go to Step 3	DO MAN	go to Step 5
If you select...	Then...								
DO AUTO	go to Step 3								
DO MAN	go to Step 5								
3	DO AUTO Set 0 % value		<p>The decrement relay is turned on to move the motor to 0 % position.</p> <p><i>Upper Display</i> = (counts of slidewire feedback 0-3000) <i>Lower Display</i> = ZERO VAL</p> <p>When the motor stops, the display should stop counting, then go to the next step.</p>						
4	DO AUTO Set 100 % value		<p>The increment relay is turned on to move the motor to 100 % position.</p> <p><i>Upper Display</i> = (counts of slidewire feedback 0-3000) <i>Lower Display</i> = SPAN VAL</p> <p>When the motor stops, the display should stop counting, then, go to Step 8.</p>						
5	DO MAN Set 0 % value		<p>You will see:</p> <p><i>Upper Display</i> = (the existing zero calibration value in counts) <i>Lower Display</i> = ZERO VAL</p>						

Step	Description	Press	Action
		 or 	until the desired zero value is reached in the upper display. <i>Upper Display</i> = (the desired zero calibration value) <i>Lower Display</i> = ZERO VAL
6	DO MAN Set 100 % value		The controller will store the 0 % value and you will see: <i>Upper Display</i> = (the existing span calibration value in counts) <i>Lower Display</i> = SPAN VAL
		 or 	until the desired span value is reached in the upper display. <i>Upper Display</i> = (the desired span calibration value) <i>Lower Display</i> = SPAN VAL
			For manual calibration, the motor does not move from its position prior to the start of Position Proportional calibration.
7	Exit the Calibration Mode		The controller will store the 100 % value.
			To exit the calibration mode
		or	
			

6.5 Restore Output Factory Calibration

Introduction

The factory calibration constants for the Current and Auxiliary Outputs are stored in its non-volatile memory. Thus, you can quickly restore the “Factory Calibration” for those outputs by simply changing the CO RANGE setting for that output to the other setting and then changing it back to the original type.





Refer to *Table 6-6 Restore Factory Calibration for procedure*

ATTENTION



A restored factory calibration overwrites any previous field calibration done for the output. Protect your field calibration from accidental overwrites by configuring the appropriate LOCKOUT selection after calibration.

See *Section 3 - Configuration* for specific instructions to set the lockout.

Table 6-6 Restore Factory Calibration

Step	Operation	Press	Result
1	Set LOCKOUT to NONE	 	until you see: <i>Upper Display</i> = SET UP <i>Lower Display</i> = TUNING Until you see: <i>Upper Display</i> = one of the following: NONE – all parameters are read/write CALIB – all parameters are read/write except Calibration +CONF – configuration parameters are Read Only; no writes permitted +VIEW – Tuning and Setpoint Ramp parameters are read/write. No other parameters can be viewed. ALL – Tuning and Setpoint Ramp parameters are available for read only. No other parameters can be viewed. <i>Lower Display</i> = LOCKOUT
		or	Until NONE is in the upper display
2	Enter OUTPUT or OPTIONS Setup Group	 	until you see: <i>Upper Display</i> = SET UP <i>Lower Display</i> = OUTPUT (for the Current Output) - or - <i>Lower Display</i> = OPTIONS (for the Auxiliary Output)
		or	until you see: <i>Upper Display</i> = the current selection <i>Lower Display</i> = CO RANGE
		or	to change the range configuration to the other selection
3	Scroll through Functions		until the lower display rolls through the rest of the functions and returns to: <i>Upper Display</i> = the new selection <i>Lower Display</i> = CO RANGE

Output Calibration

Step	Operation	Press	Result
		 or 	to change the range selection in the upper display back to the proper selection. You will see: <i>Upper Display</i> = Original range selection <i>Lower Display</i> = CO RANGE
4	Return to Normal Operation		to return to Normal operating mode. The factory calibration will be restored. If the problem is not corrected, contact the Honeywell Technical Assistance Center at 1-800-423-9883 USA and Canada

7 Troubleshooting/Service

7.1 Overview

Introduction

Instrument performance can be adversely affected by installation and application problems as well as by hardware problems. We recommend that you investigate the problems in the following order:

- installation related problems
- application related problems
- hardware and software related problems

and use the information presented in this section to solve them.

What's in this section?

The following topics are covered in this section.

TOPIC		See Page
7.1	Overview	155
7.2	Troubleshooting Aids <ul style="list-style-type: none"> • Overall Error Messages • Controller Failure Symptoms • Customer Support • Determining the Software Version Number 	156
7.3	Power-up Tests	158
7.4	Status Tests	158
7.5	Background Tests	159
7.6	Controller Failure Symptoms	160
7.7	Troubleshooting Procedures <ul style="list-style-type: none"> • Power Failure • Current Proportional Output Failure • Time Proportional Output Failure • Time/Current - Current/Time Proportional Output Failure • Alarm Relay Output Failure • Keyboard Failure 	162
7.8	Restore Factory Configuration	172
7.9	Software Upgrades	173

Installation related problems

Read the Installation section in this manual to make sure the UDC3200 has been properly installed. The installation section provides information on protection against electrical noise, connecting external equipment to the controller, and shielding and routing external wiring.

ATTENTION System noise induced into the controller will result in diagnostic error messages recurring. If the diagnostic error messages can be cleared, it indicates a “soft” failure and is probably noise related.

If system noise is suspected, completely isolate the controller from all field wiring. Use calibration sources to simulate PV and check all controller functions; i.e. Gain, Rate, Reset, Output, Alarms, etc.

Application related problems

Review the application of the controller; then, if necessary, direct your questions to the local sales office.

Hardware and software related problems

Use the troubleshooting error message prompts and controller failure symptoms to identify typical failures which may occur in the controller. Follow the troubleshooting procedures to correct them.

7.2 Troubleshooting Aids

Overall error messages

An error message can occur:

- At power-up. See Subsection 7.3.
- When the Status Tests are requested. See Subsection 7.4.
- During continuous background tests while in normal operation. See Subsection 7.5.

Controller failure symptoms

Other failures may occur that deal with the Power, Output, or Alarms. Refer to the controller failure symptom in Table 7-4 to determine what is wrong and the troubleshooting procedures to use to correct the problem.

Check installation

If a set of symptoms still persists, refer to *Section 2 - Installation* and ensure proper installation and proper use of the controller in the system.

Customer support

If you cannot solve the problem using the troubleshooting procedures listed in this section, you can get **technical assistance** by dialing 1-800-423-9883 USA and Canada.

An engineer will discuss your problem with you. **Please have your complete model number, serial number, and Software version available.** The model and serial numbers can be found on the chassis nameplate. The software version can be viewed under Setup Group “Status.” See Table 7-1.

If it is determined that a hardware problem exists, a replacement controller or part will be shipped with instructions for returning the defective unit.



Do not return your controller without authorization from Honeywell’s Technical Assistance Center or until the replacement has been received.

Check out Honeywell’s **web site** at <http://www.honeywell.com/imc>.

Determining the software version

Table 7-1 lists the procedure for identifying the software version number.

Table 7-1 Procedure for Identifying the Software Version

Step	Operation	Press	Result
1	Select STATUS Set Up Group		<i>Upper Display = READ</i> <i>Lower Display = STATUS</i>
2	Read the software version		You will see: <i>Upper Display = Software version number</i> 32xx <i>Lower Display = VERSION</i>

Please give this number to the Customer Support person. It will indicate which version of UDC3200 you have and help them determine a solution to your problem.

7.3 Power-up Tests

What happens at power-up

When power is applied, the controller will run three diagnostic tests. After these tests are completed, “TEST DONE” is displayed.

Failsafe Failures

If one or more of these tests fail, the controller will go to the Failsafe Manual Mode, and FAILSF will flash in the lower display and a message indicating which test failed will appear in the lower display. Then, “DONE” will appear in the lower display.

Three Position Step test failures

For controller configured for Three Position Step Control with motor position indication and Auto-cal has never been done, the prompt CAL MTR will appear to suggest that the controller be calibrated. Refer to Subsection 6.4 - Three Position Step Output Calibration.

7.4 Status Tests



Introduction

When required, the results of these tests can be checked to determine the reason the controller has gone to Failsafe.

How to check the status tests

The procedure in Table 7-2 tells you how to display the results of the status tests.

Table 7-2 Procedure for Displaying the Status Test Results

Step	Operation	Press	Result
1	Select STATUS Set Up Group		Upper Display = READ Lower Display = STATUS
2	Read the test results		You will see: Upper Display = NO or YES YES indicates a failure Lower Display = FAILSAFE
			Upper Display = PASS or FAIL Lower Display = TEST

7.5 Background Tests

Introduction

The UDC3200 performs ongoing background tests to verify data and memory integrity. If there is a malfunction, a diagnostic message will be displayed (blinking) in the lower display.

In the case of simultaneous malfunctions, the messages will appear in sequence in the lower display. Table 7-3 lists these background tests, the reason for their failure, and how to correct the problem.

Diagnostic messages may be suppressed (stop the blinking) by pressing the RUN/HOLD key. The messages will still be available for viewing by pressing the LOWER DISPLAY key.

Table 7-3 Background Tests

Lower Display	Reason for Failure	How to Correct the Problem
EE FAIL	Unable to write to non-volatile memory. Anytime you change a parameter and it is not accepted, you will see E FAIL.	<ol style="list-style-type: none"> 1. Check the accuracy of the parameter and re-enter. 2. Try to change something in configuration. 3. Run through Read STATUS tests to re-write to EEPROM.
FAILSAFE	This error message shows whenever the controller goes into a failsafe mode of operation. This will happen if: <ul style="list-style-type: none"> • RAM test failed • Configuration test failed • Calibration test failed • Burnout configured for none and the input failed. 	<ol style="list-style-type: none"> 1. Run through STATUS check to determine the reason for the failure. 2. Press the SET UP key until STATUS appears in the lower display. 3. Press the FUNCTION key to see whether the tests pass or fail, then run through the STATUS codes a second time to see if the error cleared.
INP1 RNG	Input 1 out of range. The process input is outside the range limits.	<ol style="list-style-type: none"> 1. Make sure the range and actuation are configured properly. 2. Check the input source. 3. Restore the factory calibration. (See Subsection 5.6.) 4. Field calibrate. See Section 5 - Input Calibration.
INP1FAIL	Two consecutive failures of input 1 integration; i.e., cannot make analog to digital conversion. This will happen if: <ul style="list-style-type: none"> • Upscale or Downscale burnout is selected and the input is open • Input not configured correctly for the sensor being used • Input source is grossly out of range. 	<ol style="list-style-type: none"> 1. Make sure the actuation is configured correctly. See Section 3 - Configuration. 2. Make sure the input is correct and that it has not burned-out (opened). 3. Check for gross over-ranging with a multimeter. 4. Restore factory calibration. See Subsection 5.6.
INP2 RNG	Input 2 out of range. The remote input is outside the range limits.	Same as INP1RNG above.
INP2FAIL	Two consecutive failures of input 2 integration. i.e., cannot make analog to digital conversion.	Same as INP1FAIL above.

Lower Display	Reason for Failure	How to Correct the Problem
CONF ERR	<ul style="list-style-type: none"> • PV low limit is > PV high limit • SP low limit is > SP high limit • Output low limit > Output high limit 	<ol style="list-style-type: none"> 1. Check the configuration for each item and reconfigure if necessary.
PV LIMIT	PV out of range. $PV = INP1 \times RATIO1 + INP1 \text{ BIAS}$	<ol style="list-style-type: none"> 1. Make sure the input signal is correct. 2. Make sure the Ratio and Bias settings are correct. 3. Recheck the calibration. Use Bias of 0.0
RV LIMIT	The result of the formula shown below is beyond the range of the remote variable. $RV = INP2 \times RATIO + BIAS$	<ol style="list-style-type: none"> 1. Make sure the input signal is correct. 2. Make sure the Ratio2 and Bias2 settings are correct. 3. Recheck the calibration. Use a Ratio2 of 1.0 and a Bias2 of 0.0.
SEGERR	Setpoint Program start segment number is less than ending segment number.	Check SP Program configuration, subsection 3.5 Set up Group SPPROG function prompts "STRSEG" and "ENDSEG".
CAL MTR	Slidewire calibration never performed.	Field Calibrate the slidewire. See Section 6.4.
SW FAIL	Position Proportional slidewire input failure.	See the Trouble Shooting Procedure in Section 7.7.
SOOTING	Percent Carbon falls outside sooting boundary	Check process for correct operation.
TCx WARN	Thermocouple on Input x (1 or 2) is starting to burnout.	This diagnostic message means that the controller has detected that the thermocouple is starting to burnout. This error message may also be created if the resistance of the wires used to connect the thermocouple to the instrument is above 100 ohms.
TCxFAIL	The Thermocouple on Input x (1 or 2) is in imminent danger of burning out.	This diagnostic message means that the controller has detected that the thermocouple will soon fail. User should consider replacing the thermocouple as soon as possible. This message will also be generated if the resistance of the wires used to connect the thermocouple to the instrument is above 180 ohms.
CURFAIL	Current Output is less than 3.5 mA.	The current output is open circuit. Check the field wiring. See Procedure #2.
AXFAIL	Auxiliary Output is less than 3.5 mA.	The auxiliary output is open circuit. Check the field wiring. See Procedure #9.

7.6 Controller Failure Symptoms

Introduction

In addition to the error message prompts, there are failure symptoms that can be identified by noting how the controller displays and indicators are reacting.

Symptoms

Compare your symptoms with those shown in Table 7-4.

Table 7-4 Controller Failure Symptoms

Upper Display	Lower Display	Indicators	Controller Output	Probable Cause	Troubleshooting Procedure
Upper Display	Lower Display	Indicators	Controller Output	Probable Cause	Troubleshooting Procedure
Blank	Blank	Off	None	Power Failure	1
OK	Displayed Output disagrees with Controller Output	OK	Controller Output disagrees with Displayed Output	Current Proportional Output	2
OK		OK		Position Proportional or TPSC Output	3
OK		OK		Time Proportional Output	4
OK		OK		Current/Time Proportional Output	5
OK	OK	OK	External Alarm function does not operate properly	Malfunction in alarm output	6
Display does not change when a key is pressed				Keyboard Malfunction	7
Controller fails to go into "Slave" operation during communications				Communications Failure	8
OK	Displayed Output disagrees with Auxiliary Output	OK	Controller Auxiliary Output disagrees with Displayed Auxiliary Output	Auxiliary Output	9

Other symptoms

If a set of symptoms or prompts other than the one you started with appears while troubleshooting, re-evaluate the symptoms. This may lead to a different troubleshooting procedure.

If the symptom still persists, refer to the installation section in this manual to ensure proper installation and proper use of the controller in your system.

7.7 Troubleshooting Procedures

Introduction

The troubleshooting procedures are listed in numerical order as they appear in Table 7-4. Each procedure lists what to do if you have that particular failure and how to do it or where to find the data needed to accomplish the task.



WARNING—SHOCK HAZARD

TROUBLESHOOTING MAY REQUIRE ACCESS TO HAZARDOUS LIVE CIRCUITS, AND SHOULD ONLY BE PERFORMED BY QUALIFIED SERVICE PERSONNEL. MORE THAN ONE SWITCH MAY BE REQUIRED TO DE-ENERGIZE UNIT BEFORE SERVICING.

Equipment needed

You will need the following equipment in order to troubleshoot the symptoms listed in the tables that follow:

- Multimeter – Capable of measuring millivolts, milliamps and resistance.
- Calibration sources – T/C, mV, Volt, etc.

Procedure #1

Table 7-5 explains how to troubleshoot power failure symptoms.

Table 7-5 Troubleshooting Power Failure Symptoms

Step	What to do	How to do it
1	Check the AC line voltage.	Use a voltmeter to measure the AC voltage across terminals L1 and L2 on the rear terminal panel of the controller. Check the earth ground connection.
2	Make sure the chassis plugs into the rear of the case properly.	Withdraw the chassis and visually inspect the controller board and the inside of the case.
3	Check the system for Brown-outs, heavy load switching, etc., and conformance to installation instructions.	Refer to <i>Section 2 - Installation</i> .
4	Change Power board.	Installation instructions supplied with new board.

Procedure #2

Table 7-6 explains how to troubleshoot Current Output failure symptoms.

Table 7-6 Troubleshooting Current Output Failure

Step	What to do	How to do it
1	Make sure the controller is configured for Current output and the proper range (4 to 20 or 0 to 20) is configured.	Make Output Set Up group function prompt OUT ALG = CUR. Make the Output Set UP group function prompt CRANGE = 4-20 or 0-20 per your application. Refer to <i>Section 3 - Configuration</i> .
2	Check the field wiring.	Output impedance must be less than or equal to 1000 ohms.
3	Check the output.	Put the controller into Manual mode and change the output from 0 % to 100 % (4-20 mA). Use a DC milliammeter at the rear terminals to verify the output.
4	Recalibrate the Current Proportional output.	Refer to <i>Section 6 - Output Calibration</i> for details.
5	Change Current Output board.	Installation instructions provided with new board.
6	Change Controller	

Procedure #3

Table 7-7 explains how to troubleshoot Position Proportional Output failure symptoms.

Table 7-7 Troubleshooting Position Proportional Output Failure

Step	What to do	How to do it
1	Make certain that the controller is configured for Position Proportional output.	Make Output Algorithm Set Up group function prompt OUT ALG = POSITON. Refer to <i>Section 3 - Configuration</i> .
2	Check the field wiring.	Refer to <i>Section 2 - Installation</i> for details.
3	Check the output.	Put the controller into Manual mode and change the output from 0 % to 100 %.
4	Check whether the motor drives in both directions. If it does go to Step 6.	See the Position Proportional calibration procedure in <i>Section 6 - Output Calibration</i> for motor slidewire calibration.
5	Check whether the motor drives in either direction. If the motor drives only in one direction, check the slidewire. If the motor does not drive in either direction, check the motor.	Refer to the motor instructions.
6	Check the output voltage to the slidewire (if used).	See the Input 2 wiring diagram for terminal designations in <i>Section 2 – Installation</i> . 1) Measure between the R and the – terminals (across the entire slidewire). This voltage should be between 0.024 volts (for a 100 ohm slidewire) and 0.200 volts (for a 1000 ohm slidewire). This voltage should remain steady as the motor moves. 2) Measure between the + and the – terminals (across just the wiper section). This voltage should be somewhere between 0.002 and 0.200 volts, depending upon the total slidewire resistance and the current position of the slidewire. This voltage should vary smoothly as the motor moves and the wiper travels across the slidewire. If the voltage jumps at a particular position while the motor is moving, this could indicate a “deadspot” and mean that the slidewire may be worn out and need replacing. Refer to the motor manufacturer’s instructions.

7	Make sure the output relays are actuating properly.	<p>Put the controller into Manual mode. Vary the output above and below the present value. Observe "OUT" indicators and the output value ("OUT") on the lower display. When the "OUT 1" indicator is on, the output value should be increasing. When the "OUT 2" indicator is on, the output value should be decreasing.</p> <p>If these are not working properly, check the field wiring, then go to Step 5.</p> <p>If they are, go to Step 8.</p>
8	Recalibrate the controller.	Refer to <i>Section 6 - Output Calibration</i> .
9	Change the two Output Relays or the Dual Relay Board (depending upon unit)	Installation instructions supplied with the new relays or board.

Procedure #4

Table 7-8 explains how to troubleshoot Time Proportional Output failure.

Table 7-8 Troubleshooting Time Proportional Output Failure

Step	What to do	How to do it
1	Make sure the controller is configured for Time Proportional output.	<p>Make Output Algorithm Set Up group function prompt OUTALG = RLY or RLYD.</p> <p>Refer to <i>Section 3 - Configuration</i>.</p>
2	Check the field wiring.	<p>Make sure the NO or NC contact wiring is correct.</p> <p>Refer to <i>Section 2 - Installation</i> for details.</p>
3	Check the output.	<p>Put the controller into Manual mode. Vary the output above and below the present value. Observe OUT1 indicator on the operator interface. Contact should change state. 0 % open, 100 % closed. Listen for a click from the relay when the OUT1 indicator changes state.</p>
4	Check relay.	Change relay.
5	Change MCU board.	Installation instructions supplied with the new board.

Procedure #5

Table 7-9 explains how to troubleshoot Current/Time or Time/Current Proportional Output failure.

Table 7-9 Troubleshooting Current/Time or Time/Current Proportional Output Failure

Step	What to do	How to do it
1	Make sure the controller is configured for Time/Current or Current/Time Proportional output.	Make Output Algorithm Set Up group function prompt OUT ALG = TCUR or CURT. Refer to <i>Section 3 – Configuration</i> .
2	Check the field wiring.	Make sure the NO or NC contact wiring selection is correct. Refer to <i>Section 2 - Installation</i> for details.
3	Check the relay output.	Put the controller into Manual mode. Vary the output above and below the present value. Observe OUT1 indicator on the operator interface. Listen for a click from the relay when the OUT1 indicator changes state.
4	Check the Current Proportional Output.	Put the controller into Manual mode and change the output from 0 % to 100 % (4-20 mA). Use a DC milliammeter at the rear terminals to verify the output.
5	Recalibrate the controller.	Refer to <i>Section 6 - Output Calibration</i> for details.
6	Change MCU and/or Current Output boards.	Installation instructions supplied with new board.

Procedure #6

Table 7-10 explains how to troubleshoot Alarm Relay Output failure.

Table 7-10 Troubleshooting Alarm Relay Output Failure

Step	What to do	How to do it
1	Check the alarm configuration data. If it is correct, check the field wiring.	Reconfigure if necessary. Refer to <i>Section 3 - Configuration</i> for details.
2	Check that the applicable alarm relay actuates properly depending on what you have set at prompt AxSxTYPE. If it does, check the field wiring.	If the alarm type is set for PV, place the controller in manual mode. Vary the input to raise and lower the PV around the setpoint. Listen for a click from the relay as the PV moves in either direction and note that the proper ALM1 or ALM2 is lit. EXAMPLE: If the alarm is set for MAN, put the controller into manual mode. The alarm light is ON. Put the controller into automatic mode and the alarm light is OFF.
3	Check the contacts.	Make sure the NO or NC contact wiring is correct. Refer to <i>Section 2 - Installation</i> for relay contact information.
4	Change the relay and/or the current output board.	Installation instructions supplied with the new relay or board.
5	Change MCU board.	Installation instructions supplied with the new board.

Procedure #7

Table 7-11 explains how to troubleshoot a Keyboard failure.



Table 7-11 Troubleshooting a Keyboard Failure

Step	What to do	How to do it
1	Make sure the keyboard is connected properly to the MCU/output and power/input boards.	Withdraw the chassis from the case and visually inspect the connection.
2	Controller Keyboard or specific keys may be LOCKED OUT via the security code.	Use your four-digit security code number to change the lockout level. Refer to <i>Section 3 – Configuration</i> .
3	Run the keyboard test.	<p>Press the [SET UP] key and hold in, then press the [FUNCTION] key at the same time. The controller will run a display test. Then you will see:</p> <p style="text-align: center;">Upper Display <div style="border: 1px solid black; padding: 2px; display: inline-block;">KEYS</div></p> <p style="text-align: center;">Lower Display <div style="border: 1px solid black; padding: 2px; display: inline-block;">TRY ALL</div></p> <p>Press each key. If it works, the key name will appear in the lower display.</p>
4	Replace the display/keyboard if any keys do not function.	Refer to <i>“Parts Replacement Procedures”</i> in this section.

Procedure #8

Table 7-11 explains how to troubleshoot a RS 485 Communications failure.

Table 7-12 Troubleshooting a RS-485 Communications Failure

Step	What to do	How to do it
1	Check the Address Number, ComState and Baud Rate settings.	See Section 3.13.
2	Check the field wiring and termination resistor.	Using an ohm meter, check the resistance across the communications rear terminals. See Section 2.7 for wiring diagrams.
3	Make sure the Communications Printed Wiring Board is installed properly in the controller.	Withdraw the chassis from the case and inspect the board. See the exploded view (Figure 8-1) for location of the board. Return the chassis to the case.
4	Determine if the Communications board is faulty by running a LOCAL LOOPBACK TEST.	Disconnect the communications cable from the rear terminals. Run the Local Loopback Test.
	If the test fails, replace the board. If the test passes, the problem is most likely elsewhere in the communications network.	<p>Press [SET UP] until you see:</p> <p>Upper Display <div style="border: 1px solid black; padding: 2px; display: inline-block;">SET UP</div></p> <p>Lower Display <div style="border: 1px solid black; padding: 2px; display: inline-block;">COM</div></p> <p>Press [FUNCTION] until you see:</p> <p>Upper Display <div style="border: 1px solid black; padding: 2px; display: inline-block;">DISABLE</div></p> <p>Lower Display <div style="border: 1px solid black; padding: 2px; display: inline-block;">LOOPBACK</div></p> <p>Press  or  you will see:</p> <p>Upper Display <div style="border: 1px solid black; padding: 2px; display: inline-block;">ENABLE</div></p> <p>Lower Display <div style="border: 1px solid black; padding: 2px; display: inline-block;">LOOPBACK</div></p> <p>The test will run until the operator disables it here.</p>

Procedure #9

Table 7-13 explains how to troubleshoot an Ethernet Communications failure.

Table 7-13 Troubleshooting an Ethernet Communications Failure

Step	What to do	How to do it
1	Check the IP address, Subnet Mask address and Gateway address settings.	See the PIE Tool Manual.
2	Check if the Ethernet Connection is active.	Looking into the instrument, there should be steady green LED. If this is not present, then the instrument is not seeing a valid Ethernet connection. See Section 2.7 for wiring diagrams. A second green LED will blink during actual Ethernet transactions.
3	Change Ethernet Communications board.	Installation instructions provided with new board.
4	Change Controller	

Procedure #10

Table 7-14 explains how to troubleshoot Auxiliary Proportional Output failure symptoms.

Table 7-14 Troubleshooting Auxiliary Output Failure

Step	What to do	How to do it
1	Make sure the controller is configured for Auxiliary Output and the proper range (4 to 20 or 0 to 20) is configured.	<p>Make Options Set Up group function prompt AUX OUT any selection other than NONE. If this prompt does not show up, check if DIG IN 2 is enabled. If so, then as Auxiliary Output and Digital Input 2 are mutually exclusive, you must choose which one of these features you wish to use.</p> <p>Make the Options Set UP group function prompt CRANGE = 4-20 or 0-20 per your application.</p> <p>Refer to <i>Section 3 - Configuration</i>.</p>
2	Check the field wiring.	Output impedance must be less than or equal to 1000 ohms.
3	Check the output.	Change the AUX OUT selection to OUTPUT. Put the controller into Manual mode and change the output from 0 % to 100 % (4-20 mA). Use a DC milliammeter at the rear terminals to verify the output.
4	Recalibrate the Auxiliary output.	Refer to <i>Section 6 - Output Calibration</i> for details.
5	Change Auxiliary Output board.	Installation instructions provided with new board.
6	Change Controller	

7.8 Restoring Factory Configuration



Introduction

This procedure restores the configuration of the instrument back to the Factory Settings per Section 3.16.

ATTENTION: Restoring the factory configuration overwrites all user-entered configuration changes. This procedure cannot be undone, it is a one-way process.

Table 7-15 explains how to restore Factory Configuration.

Table 7-15 Restoring Factory Configuration

Step	What to do
1	Turn off the power to the instrument for at least five seconds.
2	Turn the power back on and simultaneously press the “FUNCTION” and  keys. This must be done while “TEST DONE” is being displayed.
3	If step 2 was performed correctly, the instrument will now display “UDC” [Upper] “UPDATE” [Lower].
4	Press the Function Key. The instrument will now display “DIS” [Upper] “RESTORE” [Lower].
5	Press the  key. The instrument will now display “CONFIG” [Upper] “RESTORE” [Lower].
6	Press the Function Key. The instrument will now display “DOIN” “RESTORE”
7	When the instrument finishes the restore operation, it automatically resets itself and restarts in the product mode. The instrument configuration will now be the same as it was when the instrument left the factory and all user-entered configurations since that time have been overwritten.

7.9 Software Upgrades

Introduction

This procedure enables software features that were not ordered from the factory. See Table 8-3 for a list of the available Software Upgrades.

ATTENTION:

This procedure cannot be undone, it is a one-way process.

Each instrument has a unique code number sequence, so the following procedure must be performed on each instrument to be upgraded.

Table 7-16 explains how to enable new software features.

Table 7-16 Software Upgrades

Step	What to do
1	Turn off the power to the instrument for at least five seconds.
2	Turn the power back on and simultaneously press the FUNCTION and ▲ keys. This must be done while “TEST DONE” is being displayed.
3	If step 2 was performed correctly, the instrument will now display “UDC” [Upper] “UPDATE” [Lower].
4	Press the Function Key. The instrument will now display DISABLE [Upper] “RESTORE” [Lower].
5	Press the ▲ key. The instrument will now display “CONFIG” [Upper] “RESTORE” [Lower].
6	Press the ▲ Key. The instrument will now display OPTIONS [Upper] “RESTORE” [Lower].
7	Press the FUNCTION Key. The instrument will now display “XXXX” [Upper] “ENTER1” [Lower], where XXXX is a unique code number for this particular instrument. Write this number down.
8	Press the FUNCTION Key. The instrument will now display “XXXX” “ENTER2”. Write this number down.
9	Press the FUNCTION Key. The instrument will now display “XXXX” “ENTER3”. Write this number down.
10	Write down the Model and Serial Numbers of your instrument.

- 11 Contact your Honeywell Representative to place an order. Please have a company purchase order number available before you call. The order entry person will ask for the following information:
1. Software Upgrade Part Number you require:
Math Software Upgrade – 50004635-501, or
Set Point Programming Software Upgrade – 50004635-502
 2. Model Number of your instrument(s)
 3. Serial Number of your instrument(s)
 4. Code Numbers 1, 2 and 3 from your instrument(s)
 5. Purchase order number.

With this information, a new code number set will be generated for your instrument.

- 12 When you have the new code number set, repeat steps 1 to 6.
- 13 Press the **FUNCTION** Key. The instrument will now display “XXXX” “ENTER1”, where XXXX is a unique code number for this particular instrument. Using the ▲ and ▼ keys, enter the new Code 1 number.
- 14 Press the **FUNCTION** Key. The instrument will now display “XXXX” “ENTER2”. Using the ▲ and ▼ keys, enter the new Code 2 number.
- 15 Press the **FUNCTION** Key. The instrument will now display “XXXX” “ENTER3”. Using the ▲ and ▼ keys, enter the new Code 3 number.
- 16 Press the **FUNCTION** Key. The instrument will process the new code numbers and add the new software feature. If the code numbers were entered incorrectly or if the wrong code numbers for this particular instrument were entered, then the controller will go into Manual Mode and flash the message “FAILSAFE” on the lower display. Check the code numbers being entered and repeat steps 12 through 16.
- 17 When the instrument finishes the operation, it automatically resets itself and restarts in the product mode. The instrument configuration now includes the added software feature(s).
-

8 Parts List

8.1 Exploded View

Introduction

Figure 8-1 is an exploded view of the UDC3200 Controller. Each part is labeled with a key number. The part numbers are listed by key number in Table 8-1. Parts not shown are listed in Table 8-2.

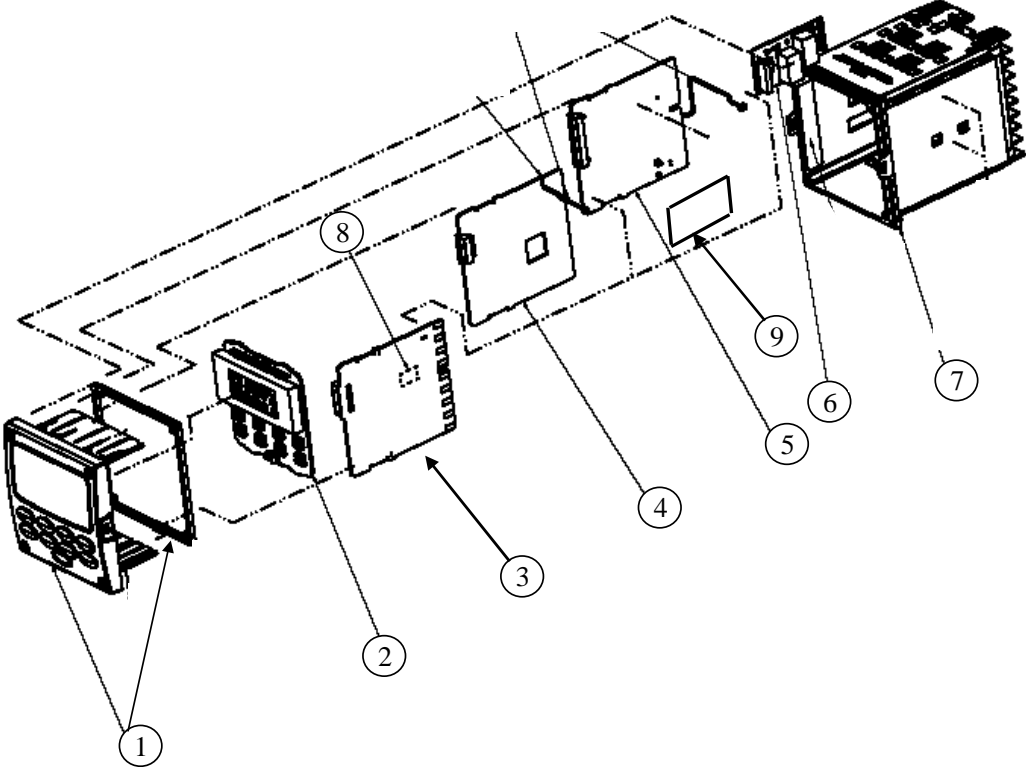

Figure 8-1 UDC3200 Exploded View

Table 8-1 Parts Identification

Key Number	Part Number	Description
1	51453143-502	Bezel Assembly and Bezel Gasket
2	51452845-501	Display/Keyboard PWA
3	51452822-502	Power/Output PWA (90-250 Vac Operation)
	51452822-503	Power/Output PWA (24 Vac/dc Operation)
4	51452810-501	Auxiliary Output/Digital Input/RS-422/485 Communications PWA
	51452816-501	Auxiliary Output/Digital Input/Ethernet Communications PWA
5	51452819-501	MCU/Input PWA
6	30755306-501 30756679-501 30756725-501 51452804-501 51452807-501	Output 1/2 <ul style="list-style-type: none"> • Electro-Mechanical Relay • Open Collector Output PWA • Solid State Relay • Current Output PWA • Dual Electromechanical Relay PWA
7	51452759-501	Case Assembly (including Mounting Kit with 4 brackets & screws)
8	30755306-501 30756679-501 30756725-501	Output 3 <ul style="list-style-type: none"> • Electro-Mechanical Relay • Open Collector Output PWA • Solid State Relay
9	51452825-501	Optional Input PWA

Table 8-2 Parts Not Shown

Part Number	Description
30731996-506	4-20 mA Input Resistor Assembly (250 ohm)
30754465-501	0-10 Volt Input Resistor Assembly (100K pair)
51452763-501	Mounting Kits (12 brackets & screws)

Table 8-3 Software Upgrades (see Section 7.9)

Part Number	Description
50004635-501	Math Options
50004635-502	Set Point Programming (SPP)

8.2 Removing the chassis

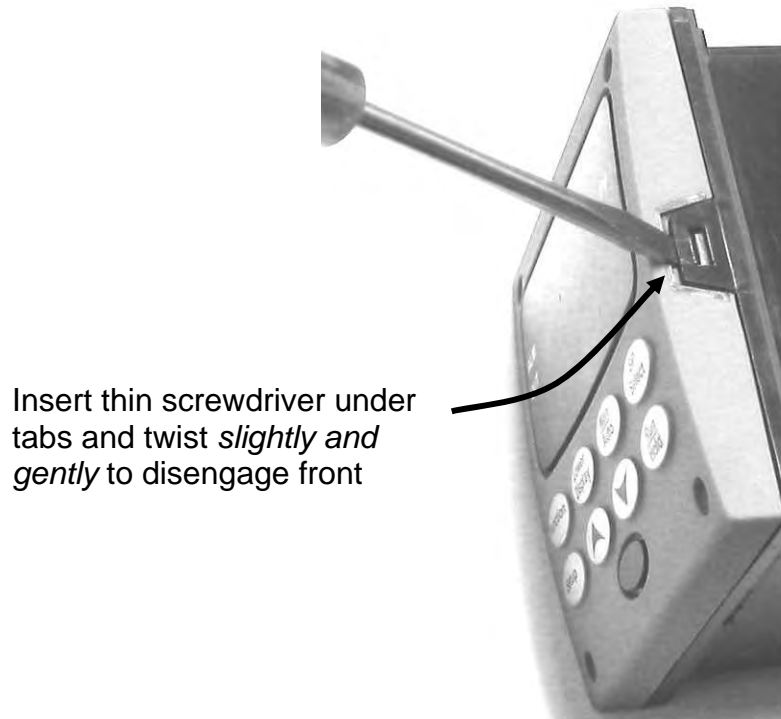

Using a thin screwdriver, *gently* twist the screwdriver to pry the side tabs from the front face. Pry just enough to release it, *otherwise you'll bend or break the tab*. If you break or bend the tab and can't reattach the front snugly, you'll need to reattach the front using the 4 NEMA4 screws provided. See Section 2.5 Mounting.

9 Modbus RTU Function Codes

9.1 Overview

This section describes the function codes needed to upload and download the configuration from a host computer into the instrument.

What's in this section?

The following topics are covered in this section.

TOPIC	See Page
9.1 Overview	178
9.2 General Information	178
9.3 Function Code 20	180
9.4 Function Code 21	184

9.2 General Information

This instrument uses a subset of the standard Modbus RTU function codes to provide access to process-related information. Several MODICON function codes are implemented. It is appropriate to define instrument-specific "user-defined" function codes. Where differences occur between the two protocols it will be noted. Several standard Modbus RTU function codes are supported.

Configuration ID Tags

Function codes **20** and **21** use the RS422/485 tag IDs for accessing configuration and process-related data. These tags are fully explained in *Section 10*.

The tag IDs represent the *register addresses* used in the Request Message.

Register Address Structure

Table 9-1 Integer Parameter Type

Register Numbers (Dec)	Name	Access	Notes
1	Type = 1	NOT SUPPORTED	16-bit Unsigned Integer
2	Attribute	NOT SUPPORTED	1 = Read Only, 2 = Read/Write
3	Value (16 bit integer)	Read / Write	
4	Not Used	NOT SUPPORTED	
5	Low Range (16 bit integer)	NOT SUPPORTED	
6	Not Used	NOT SUPPORTED	
7	High Range (16 bit Integer)	NOT SUPPORTED	
8	Not Used	NOT SUPPORTED	
9 to 13	Description Text (ASCII string)	NOT SUPPORTED	

Table 9-2 Floating Point Parameter Type

Register Numbers (Dec)	Name	Access	Notes
1	Type = 2	NOT SUPPORTED	IEEE Floating Point
2	Attribute	NOT SUPPORTED	1 = Read Only, 2 = Read/Write
3	Value (float high word)	Read / Write	
4	Value (float low word)	NOT SUPPORTED	
5	Low Range (float high word)	NOT SUPPORTED	
6	Low Range (float low word)	NOT SUPPORTED	
7	High Range (float high word)	NOT SUPPORTED	
8	High Range (float low word)	NOT SUPPORTED	
9 to 13	Description Text (ASCII string)	NOT SUPPORTED	

Register Count

The register count depends on the data format of the registers being read or written.

Integer data is represented in sixteen bits and is transferred high byte first.

Floating point data is transferred in IEEE 32-bit format.

The register count definitions are:

0001 = Integer Data

0002 = Floating Point Data

9.3 Function Code 20 (14h) - Read Configuration Reference Data

Description

Function code 20 (14 Hex) is used in this instrument to read information stored in its configuration database. Each configuration item is explicitly addressed by a file number and register address. IEEE 32-bit floating point and 16-bit integer formats are supported.

Request and Response Formats

The Request and Response formats for Function code 20 (14 Hex) are shown below. Details for each block reference follow.

Request Message Format

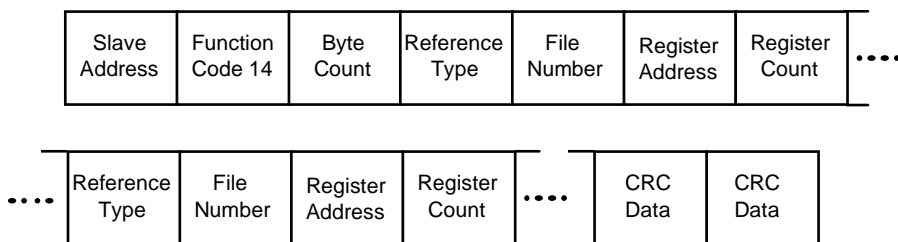

Response Message Format

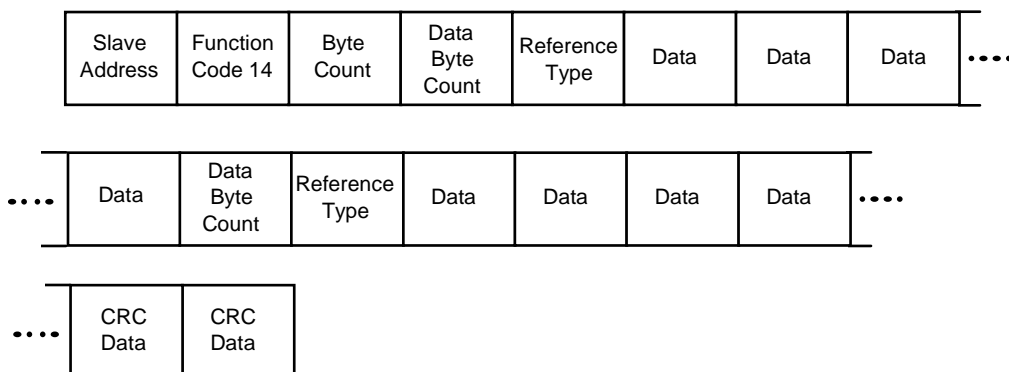

Byte Count

The Byte Count equals the number of bytes transmitted in either the request or response message and will be the minimum number required to transmit all requested data.

Data Byte Count

The Data Byte Count is the number of data bytes of the *sub response* including the Reference Type but not including itself. A floating point sub response has four bytes of data and one byte representing the reference type making the data byte count equal to five.

Reference Type Definitions

The Reference Type definition is always 06.
 See examples in Subsection 9.3.1

File Number

The file number word contains the register number from the register address structure tables on page 3. Although the register address structure tables indicate up to 13 data registers are available for access, only register address 3 is currently supported.

Register Address

The register address word represents the tag ID number for the parameter(s) being accessed. The register address word is made up of two bytes—the MSB = 00 always. The LSB contains the tag ID number. The tag ID numbers represent the parameter's register address(es). See Section 3 for the tag ID numbers.

Table 9-3 Register Address Format for Function Code 20

Register Address(es) (Decimal)	Register Address(es) (Hex)	Format
001 to 125	0001 to 007D	analog formatted data (2 registers – IEEE 32-bit floating point)
128 to 255	0080 to 00FF	integer formatted data (1 register – 16-bit integer)

9.3.1 Read Configuration Examples

Example #1

The following is an example of a request to read the Gain 1 value using Function code 20.

Request Message (Read (Gain 1) = ID Tag 001)
02 14 07 06 00 03 00 01 00 02 (CRC16)

Where:

02 = Address
14 = Function Code 20 (14 hex)
07 = Byte Count
06 = Reference Type
00,03 = File Number (Access Data Value)
00,01 = Register Address (Standard Access Gain 1 - Tag ID #1)
00 02 = Register Count (Floating Point Data)
(CRC16)

This is the response to the above request.

Response Message
02 14 06 05 06 3F C0 00 00 (CRC16)

Where:

02 = Address
14 = Function Code 20 (14 Hex)
06 = Byte Count
05 = Sub Message Length
06 = Reference Type (IEEE Floating Point)
3F C0 00 00 = 1.50 (Value of Proportional Band)
(CRC16)

Example #2

The following is another example of a request and response message using Function code 20.

Request Message (Read LSP #1 = ID Tag 39 and LSP #2 = ID Tag 53)

```
02 14 0E 06 00 03 00 27 00 02 06 00 03 00 35 00 02 (CRC16)
```

Where:

```
02      = Address
14      = Function Code 20 (14 Hex)
0E      = Byte Count
06      = Reference Type (IEEE Floating Point)
00,03   = File Number (Access Data Value)
00,27   = Register Address (Standard Access LSP #1 - ID Tag 39)
00,02   = Register Count to read (Floating Point Data)
06      = Reference Type (IEEE Floating Point)
00,03   = File Number (Access Data Value)
00,35   = Register Address (Standard Access LSP #2 - ID Tag 53)
00,02   = Register Count to read (Floating Point Data)
(CRC16)
```

This is the response to the above request.

Response Message

```
02 14 0C 05 06 43 C8 00 00 05 06 44 60 00 00 (CRC16)
```

Where:

```
02      = Address
14      = Function Code 20 (14 Hex)
0C      = Byte Count
05      = Data Byte Count (Sub Message Length)
06      = Reference Type (IEEE Floating Point)
43 C8 00 00 = 400.0 (Value of Local Setpoint #1)
05      = Data Byte Count (Sub Message Length)
06      = Reference Type (IEEE Floating Point)
44 60 00 00 = 896.0 (Value of Local Setpoint #2)
(CRC16)
```

9.4 Function Code 21 (15h) - Write Configuration Reference Data

Introduction

Function Code 21 (15 Hex) is used in this instrument to allow writes of integer and floating point values to the configuration database and override values.

The configuration database of this instrument is located in EEROM. The override values are stored in RAM.

Integer format is used to write to “Digital” configuration items. Floating Point format is used to write to “Analog” configuration items as defined by the configuration ID tags.

Write Restrictions

Care should be taken not to exceed the 100,000 write limit of the EEROM.

Request and Response Formats

The Request and Response formats for Function code 21 (15 Hex) are shown below. Details for each block reference follow.

Request Message Format

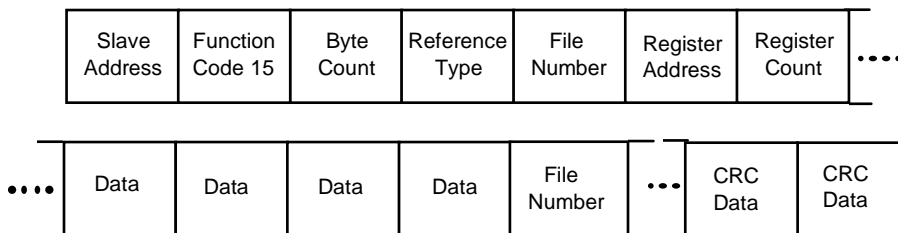

Response Message Format (echo back of request)

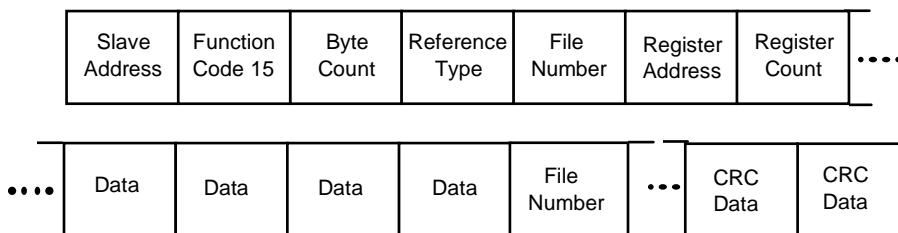

The register address is interpreted by this instrument as the tag ID configuration number.

For Infrared Transactions, add three BOFs (C0hex) at the beginning of each message and one EOF (Ffhex) at the end of each message.

Reference Type Definitions

The Reference Type definition is always 06.
See examples in Subsection 9.4.1

File Number

The file number word contains the register number from the register address structure shown in Table 9-1 and Table 9-2. Although the register address structure tables indicate up to 13 data registers are available for access, only register address 3 is currently supported.

Register Address

The register address is used to designate the tag ID number for the parameter being accessed. The register address is made up of two bytes—the MSB = 00 always. The LSB contains the RS422 tag ID number. The tag ID numbers represent the parameter's register address(es). See *Section 10* for the tag ID numbers.

Table 9-4 Register Address Format for Function Code 21

Register Address(es) (Dec)	Register Address(es) (Hex)	Format
001 to 125	0001 to 007D	analog formatted data (2 registers – IEEE 32-bit floating point)
128 to 215 & 255	0080 to 00D7 & 00FF	integer formatted data (2 registers – IEEE 32-bit floating point)

Unrestricted Registers

As mentioned previously, all register data is stored in the EEROM of this instrument with some exceptions. These exceptions were made to allow write access to override information. The registers, which are designated as Override values, are listed below. These registers do not have restrictions on the number of writes.

<i>ID Tag</i>	<i>Register Number</i>	<i>UDC Usage</i>
125	(7Dh)	Computer Setpoint

Restrictions on Parameter Numbers in One Message

The maximum number of writeable parameters per write request is 1.

9.4.1 Write Configuration Examples

Example #1

The following is an example of a request to write the Gain 1 value using Function code 21 (15 Hex).

Request Message (Write Gain 1= 1.5 “ID Tag 1”)

02 15 0B 06 00 03 00 01 00 02 3F C0 00 00 (CRC16)

Where:

02 = Address
15 = Function Code 21 (15 Hex)
0B = Byte Count
06 = Reference Type (IEEE Floating Point)
00 03 = File Number (Access Data Value)
00 01 = Register Address (Standard Access - Gain 1 - ID Tag 1)
00 02 = Register Count (Floating Point Data)
3F C0 00 00 = 1.50
(CRC16)

This is the response to the above request.

Response Message (The response is an echo of the request)

02 15 0B 06 00 01 00 02 00 02 3F C0 00 00 (CRC16)

10 Modbus Read, Write and Override Parameters plus Exception Codes

10.1 Overview

Introduction

This section contains information concerning Reading, Writing, and Overriding parameters in the UDC3200 Process Controller. There are two types of parameters:

- **Data Transfer**—These parameters include reading control data, option status, and reading or changing setpoints.
- **Configuration Data**—All the configuration data is listed in the order in which it appears in the controller.

Each type of parameter has the identifying codes listed with it.

What's in this section?

The following topics are covered in this section.

TOPIC	See Page
10.1 Overview	187
10.2 Reading Control Data	188
10.3 Read Options Status	189
10.4 Miscellaneous Read Onlys	190
10.5 Setpoints	191
10.6 Using a Computer Setpoint (Overriding Controller Setpoint)	192
10.7 Configuration Parameters	193
10.8 Modbus RTU Exception Codes	221

General Information

Non-volatile Memory Retention

- This controller uses non-volatile memory to store configuration data. These memories are guaranteed to retain data for a minimum of ten years as long as the data is not written and erased more than 10,000 times. In order not to exceed this number, it is strongly recommended that configurations which change rapidly such as Computer Setpoint use the Override feature which does not affect non-volatile memory.

Analog Parameters

- Whenever analog register addresses 0001 through 0074 (those that can be changed via communications) are changed, a Write cycle occurs after receipt of the message and the response is returned.

Override Parameters

- Override analog register address 007D (computer setpoint) is not stored in non-volatile memory. It can be changed as frequently as desired with no effect on non-volatile memory retentivity, but the controller must remain in the slave mode.

Digital Parameters

- Whenever digital configuration register addresses 0080 through 00FA are updated via communications, the non-volatile memory is updated as soon as the message is received.

Communications Transfer Rates

- Reads minimum 20mS and writes minimum 200mS

Supported Function Codes

- IR port 20 and 21
- RS485 and Ethernet ports 1,2,3,4,6,16,17,20,21

Communications Modes of Operation

- When the Shed Timer is enabled and a write or override occurs the controller will enter Slave Mode. The keypad is locked from the operator. The purpose of this mode is that if communications is lost and the shed timer times out then the controller will enter a known state of operation. The configuration of the “Shed Mode and Output” and Shed Setpoint Recall are used to configure the controller’s shed state. While in Slave Mode pushing the MAN/AUTO key enters Emergency Manual mode. The local operator then has control of the output. The controller is in Monitor Mode if the Shed timer is disabled.

10.2 Reading Control Data

Overview

The following control data can be read from the UDC3200 controller:

- Input 1
- Input 2
- PV, SP, Output

Register Addresses

Use the identifying codes listed in Table 10-1 to read the specific items.

A Write request for these codes will result in an Error message.

Table 10-1 Control Data Parameters

Parameter Description	Register Address		Data Type	Access	Data Range or Enumerated Selection
	Hex	Decimal			
Input #1	007B	123	FP	RD	In Engineering Units or Percentage
Input #2	007C	124	FP	RD	In Engineering Units or Percentage
PV, SP, Output	007A	122	FP	RD	In Engineering Units or Percentage

10.3 Read Software Options Status

Read

Doing a Read of register address 00B9 listed in Table 10-2 will tell you which of the available options are enabled / installed or disabled / not installed.

Table 10-2 Option Status

Parameter Description	Register Address		Data Type	Access	Data Range or Enumerated Selection
	Hex	Decimal			
Option Status (Read only)	00B9	185	INT	RD	See Figure 10-1.

The data field in the response message will be a decimal number from 0 to 255. Convert the decimal number to binary as shown in Figure 10-1. to determine which options are or are not active.

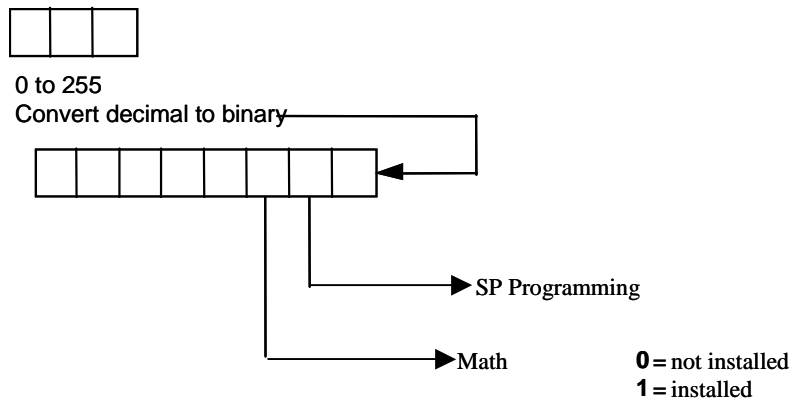

EXAMPLE: 2

Binary **0 0 0 0 0 0 1 0** SP Programming – installed

Figure 10-1 Software Option Status Information

10.4 Miscellaneous Read Onlys

10.4.1 Register Addresses for Read Onlys

The identifying register addresses listed in Table 10-3 represent some information that is Read only. No Writes allowed.

Table 10-3 Miscellaneous Read Onlys

Parameter Description	Register Address		Data Type	Access	Data Range or Enumerated Selection
	Hex	Decimal			
Software Type	009D	157	INT	RD	READ only (UDC3200) 50 = UDC3200
Software Version	00A7	167	INT	RD	READ only Value less than 255

10.4.2 SetPoint Program Read Only Information

The identifying register addresses listed in Table 10-4 represent some information for SetPoint Programming that is Read only. No Writes allowed.

Table 10-4 SetPoint Program Read Only Information

Parameter Description	Register Address		Data Type	Access	Data Range or Enumerated Selection
	Hex	Decimal			
Present SPP Segment Number	00FB	251	INT	RD	1 – 12
Segment Time Remaining in Minutes	00FC	252	INT	RD	0 – 59 Minutes
Segment Time Remaining in Hours	00FD	253	INT	RD	0 – 99 Hours
Cycles Remaining	00FE	254	INT	RD	0 – 100
Current Cycle Number	00FF	255	INT	RD	0 – 100

10.5 Setpoints

Overview

You can use two separate local setpoints in the controller. The identifying register addresses listed in Table 10-5 allow you to select which setpoint you want to use and to enter a value in Engineering Units (whichever is selected at register address 00A1) for that setpoint via communications.

Register Addresses

Make your selection using register address 00AD and enter the value for the setpoint chosen using register address in Table 10-5.

Table 10-5 Setpoint Code Selections

Parameter Description	Register Address		Data Type	Access	Data Range or Enumerated Selection
	Hex	Decimal			
Local Setpoint #1	0027	039	FP	R/W	Value within the setpoint range limits
Local Setpoint #2	0035	053	FP	R/W	Value within the setpoint range limits
Local Setpoint #3	0074	116	FP	R/W	Value within the setpoint range limits
Number of Local Setpoints	00AD	173	INT	R/W	00 = Local Setpoint #1 only 01 = 2nd Local Setpoint via keyboard or communications 03 = 3rd Local Setpoint via keyboard or communications

Associated Parameters

Refer to Table 10-6 to display or change any of the parameters associated with the setpoint.

Table 10-6 Setpoint Associated Parameters

Parameter	Register Address	
	Hex	Decimal
Setpoint Limits	0007, 0008	007, 008
Computer Setpoint	007D	125

10.6 Using a Computer Setpoint (Overriding Controller Setpoint)

Overview

You can use a setpoint generated from the computer to override the setpoint being used by the controller. The value generated by the computer will have ratio and bias applied by the controller.

Register Addresses

Use the identifying code in Table 10-7 to enter the computer setpoint.

Table 10-7 Computer Setpoint Selection

Parameter Description	Register Address		Data Type	Access	Data Range or Enumerated Selection
	Hex	Decimal			
Computer Setpoint	007D	125	FP	R/W	Value from computer with Ratio and Bias applied by the controller. Within the Setpoint Range Limits in Engineering Units or Percent.

Shed

The computer setpoint override will continue until SHED from communications occurs or the controller is placed into monitor mode through communications. Doing periodic SLAVE READS within the shed time will allow the override to continue until communication is stopped and shed time elapses. Does not apply to IR communications.

ATTENTION

0 Shed (code 79) allows the override to continue indefinitely or until the reset shed timer register address 1B90 is written using function code 6 or register address 7F using function code 21. Any data value can be written because it is ignored.

When SP is overridden, the upper display becomes “C” momentarily, and the lower display shows the CSP value as CSP XXXX.

Table 10-7.1 Shed Timer Reset

Parameter Description	Register Address		Data Type	Access	Data Range or Enumerated Selection
	Hex	Decimal			
Shed Timer Reset	007F	127	FP	W	Exit Slave Mode IR Only

Associated Parameters

Refer to Table 10-8 for the codes to display or change any of the parameters associated with the computer setpoint.

Table 10-8 Computer Setpoint Associated Parameters

Parameter	Register Address	
	Hex	Decimal
Setpoint Limits	0007, 0008	007, 008
Local Setpoint #1	0027	039
Local Setpoint #2	0035	053
Local Setpoint #3	0074	116
Local Setpoint Selection	00AD	173
Computer Setpoint Ratio	005A	90
Computer Setpoint Bias	005B	91
Shed Timer Reset	007F	127

10.7 Configuration Parameters

Overview

Listed on the next pages are the identifying codes for the parameters in the various Set-up Groups in the UDC3200 Process Controller. Most of the parameters are configurable through the hosts. Some are Read Only and are indicated as such and cannot be changed.

Reading or Writing

Do a Read or Write, depending on your requirements, using the identifying code and format code listed in the tables. The range or selection available for each range is listed in the tables.

10.7.1 Tuning

Table 10-9 lists all the register addresses and ranges or selections for the function parameters in the Set-up Group Tuning.

Table 10-9 Set-up Group – Tuning

Parameter Description	Register Address		Data Type	Access	Data Range or Enumerated Selection
	Hex	Decimal			
Gain #1 or PB Note 1	0001	001	FP	R/W	0.01 to 1000 Gain 0.1 to 1000 PB
Rate #1 Note 1	0002	002	FP	R/W	0.00 to 10.00
Reset #1 Note 1	0003	003	FP	R/W	0.02 to 50.00
Manual Reset	000D	013	FP	R/W	-100 to +100
Gain #2 or PB #2 Note 1	0004	004	FP	R/W	0.01 to 1000 Gain 0.1 to 1000 PB
Rate #2 Note 1	0005	005	FP	R/W	0.00 to 10.00
Reset #2 Note 1	0006	006	FP	R/W	0.02 to 50.00
Cycle Time #1	0015	21	INT	R/W	1 to 120 seconds
Cycle Time #2	0016	22	INT	R/W	1 to 120 seconds

Parameter Description	Register Address		Data Type	Access	Data Range or Enumerated Selection
	Hex	Decimal			
Lockout (keyboard only) Changes to data are always possible via communications regardless of this configuration.	0084	132	INT	R/W	0 = No Lockout 1 = Calibration Locked out 2 = +Configuration – Timer, Tuning, SP Ramp, Accutune are read/write 3 = +View – Tuning and SP Ramp are read/write, no other parameters are available 4 = Maximum Lockout
Security Code	0050	080	INT	R/W	0 to 9999
Man/Auto Key Lockout	00BF	191	INT	R/W	0 = Disable 1 = Enable
Run/Hold Key Lockout	00EE	238	INT	R/W	0 = Disable 1 = Enable
Setpoint Key Lockout	00ED	237	INT	R/W	0 = Disable 1 = Enable

NOTE 1: Writes to these locations are not available when Accutune is enabled.

10.7.2 SP Ramp/Rate/Program

Table 10-10 lists all the register addresses and ranges or selections for the function parameters in Set-up Group Setpoint Ramp/Rate.

Table 10-10 Set-up Group – Setpoint Ramp/Rate

Parameter Description	Register Address		Data Type	Access	Data Range or Enumerated Selection
	Hex	Decimal			
SP Ramp	0096	150	INT	R/W	0 = Disabled 1 = Enabled
Single SP Ramp Time	0019	25	FP	R/W	0 to 255 (minutes)
Final Ramp SP Value	001A	026	FP	R/W	PV Range in Engineering Units
SP Rate	00F0	240	INT	R/W	0 = Disabled 1 = Enabled
Rate Up (EU/HR)	006C	108	FP	R/W	0 to 9999
Rate Down (EU/HR)	006D	109	FP	R/W	0 to 9999
Setpoint Program	00B2	178	INT	R/W	0 = Disabled 1 = Enabled
Start Segment #	0058	88	FP	R/W	1 to 12
End Segment #(Soak)	00B0	176	INT	R/W	0 = Soak 2 1 = Soak 4 2 = Soak 6 3 = Soak 8 4 = Soak 10 5 = Soak 12
Engineering Units or Ramp Segments	00B6	182	INT	R/W	0 = HRS:MIN 1 = Degrees/Minute 2 = EU/Hour
Program Recycles	0059	89	FP	R/W	0 to 100
Guaranteed Soak Deviation	0057	087	FP	R/W	0 to 99.9 (0 = no soak)
Program End State	00B5	181	INT	R/W	0 = Disable SP Program 1 = Hold at Program End

Parameter Description	Register Address		Data Type	Access	Data Range or Enumerated Selection
	Hex	Decimal			
Controller Status at Program End	00B4	180	INT	R/W	0 = Last Setpoint and Mode 1 = Manual, Failsafe Output
Reset SP Program (ToBEGIN)	00B3	179	INT	R/W	0 = Disable 1 = Via Keypad
PV Hotstart	00E2	226	INT	R/W	0 = Disabled 1 = Enabled
Segment #1 Ramp Time	0039	057	FP	R/W	99.59 (0-99 Hrs:0-59 Min) or 0 to 999 (Degrees/Minute)
Segment #2 Soak Setpoint Value	003A	058	FP	R/W	Within Setpoint Limits
Segment #2 Soak Time	003B	059	FP	R/W	99.59 (0-99 Hrs:0-59 Min)
Segment #3 Ramp Time	003C	060	FP	R/W	99.59 (0-99 Hrs:0-59 Min) or 0 to 999 (Degrees/Minute)
Segment #4 Soak Setpoint Value	003D	061	FP	R/W	Within Setpoint Limits
Segment #4 Soak Time	003E	062	FP	R/W	99.59 (0-99 Hrs:0-59 Min)
Segment #5 Ramp Time	003F	063	FP	R/W	99.59 (0-99 Hrs:0-59 Min) or 0 to 999 (Degrees/Minute)
Segment #6 Soak Setpoint Value	0040	064	FP	R/W	Within Setpoint Limits
Segment #6 Soak Time	0041	065	FP	R/W	99.59 (0-99 Hrs:0-59 Min)
Segment #7 Ramp Time	0042	066	FP	R/W	99.59 (0-99 Hrs:0-59 Min) or 0 to 999 (Degrees/Minute)
Segment #8 Soak Setpoint Value	0043	067	FP	R/W	Within Setpoint Limits

Parameter Description	Register Address		Data Type	Access	Data Range or Enumerated Selection
	Hex	Decimal			
Segment #8 Soak Time	0044	068	FP	R/W	99.59 (0-99 Hrs:0-59 Min)
Segment #9 Ramp Time	0045	069	FP	R/W	99.59 (0-99 Hrs:0-59 Min) or 0 to 999 (Degrees/Minute)
Segment #10 Soak Setpoint Value	0046	070	FP	R/W	Within Setpoint Limits
Segment #10 Soak Time	0047	071	FP	R/W	99.59 (0-99 Hrs:0-59 Min)
Segment #11 Ramp Time	0048	072	FP	R/W	99.59 (0-99 Hrs:0-59 Min) or 0 to 999 (Degrees/Minute)
Segment #12 Soak Setpoint Value	0049	073	FP	R/W	Within Setpoint Limits
Segment #12 Soak Time	004A	074	FP	R/W	99.59 (0-99 Hrs:0-59 Min)

10.7.3 Accutune

Table 10-11 lists all the register addresses and ranges or selections for the function parameters in Set-up Group Adaptive Tune.

Table 10-11 Set-up Group – Adaptive Tune

Parameter Description	Register Address		Data Type	Access	Data Range or Enumerated Selection
	Hex	Decimal			
Fuzzy Overshoot Suppression	00C1	193	INT	R/W	0 = Disabled 1 = Enabled
Accutune Enable	0098	152	INT	R/W	0 = Accutune Disabled 1 = Tune
Accutune Duplex selection	00E1	225	INT	R/W	0 = Manual 1 = Auto 2 = Disable (blend)
Accutune Error (Read only)	0097	151	INT	R/W	0 = None 3 = Process Identification failed 4 = Accutune aborted on command 5 = Running

10.7.4 Algorithm

Table 10-12 lists all the register addresses and ranges or selections for the function parameters in Set-up Group Algorithm.

Table 10-12 Set-up Group – Algorithm

Parameter Description	Register Address		Data Type	Access	Data Range or Enumerated Selection
	Hex	Decimal			
Control Algorithm Selection (Selection here will affect ID code 160 in Output Algorithms.)	0080	128	INT	R/W	0 = ON/OFF 1 = PID-A 2 = PID-B 3 = PD-A with Manual Reset 4 = Three Position Step 5 = Disable
Timer	00D8	216	INT	R/W	0 = Disable 1 = Enable
Period	0063	099	FP	R/W	00.00 TO 99.59
Start (Initiation)	00D9	217	INT	R/W	0 = Key (Run/Hold Key) 1 = Alarm 2
LDISP (Selection)	00DA	218	INT	R/W	0 = TI REM 1 = Elapsed Time
Timer Reset	00D6	214	INT	R/W	0 = Key (Run/Hold Key) 1 = AL1 (Alarm 1 or Key)
Timer Increment	00D7	215	INT	R/W	0 = Minutes (Counts hr/minute) 1 = Sec (Counts min/sec)

Parameter Description	Register Address		Data Type	Access	Data Range or Enumerated Selection
	Hex	Decimal			
Input Algorithm 1 † Input source selected via ID 205, 206, 207.	00CC	204	INT	R/W	0 = None 1 = Weighted Average (LSP) † 2 = Feedforward – Summer † 3 = Feedforward – Multiplier † 4 = Unused 5 = Summer (with ratio and bias) † 6 = Input High Select (with ratio and bias) † 7 = Input low Select (with ratio and bias) † 8 = General Math A (sq. rt., mult., div.) † 9 = General Math B (sq. rt., mult.) † 10 = General Math C (mult., div.) † 11 = General Math D (mult.) † 12 = Carbon A 13 = Carbon B 14 = Carbon C 15 = Carbon D 16 = Carbon FCC 17 = Dewpoint 18 = Oxygen
Constant K	002D	045	FP	R/W	0.001 to 1000
Calc High	001F	031	FP	R/W	–999.0 to +9999 in Engineering Units
Calc Low	0020	032	FP	R/W	–999.0 to +9999 in Engineering Units
PV Range Low	0036	054	FP	RD	–999.0 to +9999 in Engineering Units
PV Range High	0037	055	FP	RD	–999.0 to +9999 in Engineering Units

Parameter Description	Register Address		Data Type	Access	Data Range or Enumerated Selection
	Hex	Decimal			
Input Algorithm 1 Input A Selection (used with ID 204 math calculations)	00CD	205	INT	R/W	0 = Input 1 1 = Input 2 2 = Output
Input Algorithm 1 Input B Selection (used with ID 204 math calculations)	00CE	206	INT	R/W	0 = Input 1 1 = Input 2 2 = Output
Input Algorithm 1 Input C Selection (used with ID 204 math calculations)	00CF	207	INT	R/W	0 = None 1 = Input 1 2 = Input 2 3 = Output
Algorithm1 bias	005C	092	FP	R/W	-999.0 to 9999 in Engineering Units
Percent Carbon Value	002E	046	FP	R/W	0.02 to 0.350
Percent Hydrogen	0022	034	FP	R/W	1 to 99 (% H2)

10.7.5 Output Algorithms

Table 10-13 lists all the register addresses and ranges or selections for the function parameters in Set-up Group Output.

Table 10-13 Set-up Group – Output

Parameter Description	Register Address		Data Type	Access	Data Range or Enumerated Selection
	Hex	Decimal			
Output Algorithm	00A0	160	INT	R/W	0 = Time Simplex 1 = Current Simplex 2 = Three Position Step or Position Proportioning 3 = Time Duplex 4 = Current Duplex 5 = Current/Time Duplex 6 = Time/Current Duplex
Relay Cycle Time Increments	00BE	190	INT	R/W	0 = 1 second increments 1 = 1/3 second increments
Motor Time for Positional Proportional	004B	075	INT	R/W	5 to 1800 seconds
Relay Output Action	00F3	243	INT	R/W	0 = 1 OFF 2 OFF 1 = 1 ON 2 OFF 2 = 1 OFF 2 ON 3 = 1 ON 2 ON
Current Range for Current Duplex	0099	153	INT	R/W	0 = Full (100%) 1 = Split (50%)
Current Output (Auxiliary Output Mode)	00F2	242	INT	R/W	0 = Disable 1 = Input 1 2 = Input 2 3 = PV 4 = Deviation 5 = Output 6 = SP 7 = LSP 8 = RSP 9 = Input Algorithm 1
Current Output Range	00EB	235	INT	R/W	0 = 4-20 mA 1 = 0-20 mA

Parameter Description	Register Address		Data Type	Access	Data Range or Enumerated Selection
	Hex	Decimal			
Current Low Scaling Factor	0064	100	FP	R/W	Within the range of the selected variable in ID 242
Current High Scaling Factor	0065	101	FP	R/W	Within the range of the selected variable in ID 242

10.7.6 Input 1

Table 10-14 lists all the register addresses and ranges or selections for the function parameters in Set-up Group Input 1.

Table 10-14 Set-up Group – Input 1

Parameter Description	Register Address		Data Type	Access	Data Range or Enumerated Selection
	Hex	Decimal			
Input 1 Type	00A8	168	INT	R/W	1 = B TC 2 = E TC H 3 = E TC L 4 = J TC H 5 = J TC M 6 = J TC L 7 = K TC H 8 = K TC M 9 = K TC L 10 = NNM H 11 = NNM L 12 = Nicrosil H TC 13 = Nicrosil L TC 14 = R TC 15 = S TC 16 = T TC H 17 = T TC L 18 = W TC H 19 = W TC L 20 = 100 PT RTD 21 = 100 PT LO RTD 22 = 200 PT RTD 23 = 500 PT RTD 24 = Radiamatic RH 25 = Radiamatic RI 26 = 0-20 mA 27 = 4-20 mA 28 = 0-10 mV 29 = 0-50 mV 30 = 100 mV 31 = 0-5 Vdc 32 = 1-5 Vdc 33 = 0-10 Vdc 34 = Unused 35 = Carbon 36 = Oxygen 37 = Thermocouple Differential
ATTENTION					
Changing the Input Type will result in the loss of Field Calibration values and will restore the Factory Calibration values.					

Parameter Description	Register Address		Data Type	Access	Data Range or Enumerated Selection
	Hex	Decimal			
Input 1 Transmitter Characterization	00A9	169	INT	R/W	0 = B TC 1 = E TC H 2 = E TC L 3 = J TC H 4 = J TC M 5 = J TC L 6 = K TC H 7 = K TC M 8 = K TC L 9 = NNM H 10 = NNM L 11 = Nicrosil H TC 12 = Nicrosil L TC 13 = R TC 14 = S TC 15 = T TC H 16 = T TC L 17 = W TC H 18 = W TC L 19 = 100 PT RTD 20 = 100 PT LO RTD 21 = 200 PT RTD 22 = 500 PT RTD 23 = Radiamatic RH 24 = Radiamatic RI 25 = Linear 26 = Square Root
Input 1 High Range Value	001D	029	FP	R/W	-999. to 9999. Engineering Units (Linear types only)
Input 1 Low Range Value	001E	030	FP	R/W	-999 to 9999. Engineering Units (Linear types only)
Input 1 Ratio	006A	106	FP	R/W	-20.00 to 20.00
Input 1 Bias	006B	107	FP	R/W	-999 to 9999. Engineering Units
Input 1 Filter	002A	042	FP	R/W	0 to 120 seconds

Parameter Description	Register Address		Data Type	Access	Data Range or Enumerated Selection
	Hex	Decimal			
Burnout (Open Circuit Detection)	00A4	164	INT	R/W	0 = None and Failsafe 1 = Upscale 2 = Downscale 3 = No Failsafe
Emissivity	0017	023	FP	R/W	0.01 to 1.00

10.7.7 Input 2

Table 10-15 lists all the register addresses and ranges or selections for the function parameters in Set-up Group Input 2.

Table 10-15 Set-up Group – Input 2

Parameter Description	Register Address		Data Type	Access	Data Range or Enumerated Selection
	Hex	Decimal			
Input 2 Type	00AA	170	INT	R/W	0 = Disable 1 = B TC 2 = E TC H 3 = E TC L 4 = J TC H 5 = J TC M 6 = J TC L 7 = K TC H 8 = K TC M 9 = K TC L 10 = NNM H 11 = NNML 12 = Nicrosil H TC 13 = Nicrosil L TC 14 = R TC 15 = S TC 16 = T TC H 17 = T TC L 18 = W TC H 19 = W TC L 20 = 100 PT RTD 21 = 100 PT LO RTD 22 = 200 PT RTD 23 = 500 PT RTD 24 = Radiamatic RH 25 = Radiamatic RI 26 = 0-20 mA 27 = 4-20 mA 28 = 0-10 mV 29 = 0-50 mV 30 = 0-100 mV 31 = 0-5 Vdc 32 = 1-5 Vdc 33 = 0-10 Vdc 34 = Slidewire 35 = Unused 36 = Unused 37 = Thermocouple Differential
ATTENTION					
Changing the Input Type will result in the loss of Field Calibration values and will restore the Factory Calibration values.					

Parameter Description	Register Address		Data Type	Access	Data Range or Enumerated Selection
	Hex	Decimal			
Input 2 Transmitter Characterization	00AB	171	INT	R/W	0 = B TC 1 = E TC H 2 = E TC L 3 = J TC H 4 = J TC M 5 = J TC L 6 = K TC H 7 = K TC M 8 = K TC L 9 = NNM H 10 = NNM L 11 = Nicrosil H TC 12 = Nicrosil L TC 13 = R TC 14 = S TC 15 = T TC H 16 = T TC L 17 = W TC H 18 = W TC L 19 = 100 PT RTD 20 = 100 PT LO RTD 21 = 200 PT RTD 22 = 500 PT RTD 23 = Radiamatic RH 24 = Radiamatic RI 25 = Linear 26 = Square Root
Input 2 High Range Value	0023	035	FP	R/W	-999. to 9999. Engineering Units
Input 2 Low Range Value	0024	036	FP	R/W	-999 to 9999. Engineering Units
Input 2 Ratio	0025	037	FP	R/W	-20.00 to 20.00
Input 2 Bias	0026	038	FP	R/W	-999 to 9999. Engineering Units
Input 2 Filter	002B	043	FP	R/W	0 to 120 seconds
Input 2 Emmissivity	002C	044	FP	R/W	0.01 to 1.00

Parameter Description	Register Address		Data Type	Access	Data Range or Enumerated Selection
	Hex	Decimal			
Input 2 Burnout	00A5	0165	INT	R/W	0 = None 1 = Up 2 = Down 3 = No Failsafe

10.7.8 Control

Table 10-16 lists all the register addresses and ranges or selections for the function prompts in Set-up Group Control.

Table 10-16 Set-up Group – Control

Parameter Description	Register Address		Data Type	Access	Data Range or Enumerated Selection												
	Hex	Decimal															
PV Source	0085	133	INT	R/W	0 = Input 1 1 = Input 2 2 = Input Algorithm 1												
Tuning Parameter Selection	00AC	172	INT	R/W	0 = One set only 1 = 2 sets keyboard selected 2 = 2 sets with PV automatic switchover 3 = 2 sets with setpoint (SP) automatic switchover												
Automatic Switchover Value (used with 172 selection 2 or 3)	0038	056	FP	R/W	Within the PV Range in engineering units												
Local Setpoint Source (Number of LSPs)	00AD	173	INT	R/W	0 = One Local Setpoint 1 = Two Local Setpoints 2 = Three Local Setpoints												
Power Up Mode Recall	0082	130	INT	R/W	<table border="0"> <tr> <td>Control Mode</td> <td>Setpoint Mode</td> </tr> <tr> <td>0 = MAN</td> <td>LSP</td> </tr> <tr> <td>1 = AUTO</td> <td>LSP</td> </tr> <tr> <td>2 = AUTO</td> <td>Last RSP</td> </tr> <tr> <td>3 = LAST</td> <td>Last SP</td> </tr> <tr> <td>4 = LAST</td> <td>Last Local SP</td> </tr> </table>	Control Mode	Setpoint Mode	0 = MAN	LSP	1 = AUTO	LSP	2 = AUTO	Last RSP	3 = LAST	Last SP	4 = LAST	Last Local SP
Control Mode	Setpoint Mode																
0 = MAN	LSP																
1 = AUTO	LSP																
2 = AUTO	Last RSP																
3 = LAST	Last SP																
4 = LAST	Last Local SP																
RSP Source	0083	131	INT	R/W	0 = None 1 = Input 2												
Setpoint Tracking	008A	138	INT	R/W	0 = None 1 = LSP = PV (when in Manual) 2 = LSP = RSP (when switched)												
Auto Bias	0089	137	INT	R/W	0 = Disable 1 = Enable												

Parameter Description	Register Address		Data Type	Access	Data Range or Enumerated Selection
	Hex	Decimal			
Control Setpoint High Limit	0007	007	FP	R/W	0 to 100% of PV (engineering units)
Control Setpoint Low Limit	0008	008	FP	R/W	0 to 100% of PV (engineering units)
Control Output Direction	0087	135	INT	R/W	0 = Direct 1 = Reverse
Output Rate Enable	009C	156	INT	R/W	0 = Disable 1 = Enable
Output Rate Up	006E	110	FP	R/W	0.00 to 9999% per minute
Output Rate Down	006F	111	FP	R/W	0.00 to 9999% per minute
High Output Limit	000E	014	FP	R/W	-5 to 105% of output
Low Output Limit	000F	015	FP	R/W	-5 to 105% of output
High Integral Limit	0010	016	FP	R/W	-5 to 105%
Low Integral Limit	0011	017	FP	R/W	-5 to 105%
Output Deadband for Time Duplex	004C	018	FP	R/W	-5 to +25.0%
Output Deadband for TPSC	0014	020	FP	R/W	0.5 to 5.0%
Output Drop Off Limit	0014	020	FP	R/W	-5 to 105%
Output Hysteresis	0013	019	FP	R/W	0.0 to 100.0% of PV
Failsafe Mode	00D5	213	INT	R/W	0 = Latching 1 = Non latching
Failsafe Output Level	0028	040	FP	R/W	0 to 100%
TPSC Power Output	00B7	183	INT	R/W	0 = Last 1 = Failsafe

Parameter Description	Register Address		Data Type	Access	Data Range or Enumerated Selection
	Hex	Decimal			
TPSC Failsafe Output	00B8	184	INT	R/W	0 = Motor goes to closed position (0%) 1 = Motor goes to open position (100%)
Manual Output	0071	113	FP	R/W	0 to 100%
Automatic Output	0072	114	FP	R/W	0 to 100%
Proportional Band Units	0094	148	INT	R/W	0 = Gain 1 = Proportional band
Reset Units	0095	149	INT	R/W	0 = Minutes 1 = RPM

10.7.9 Options

Table 10-18 lists all the register addresses and ranges or selections for the function parameters in Set-up Group Options.

Table 10-17 Set-up Group – Options

Parameter Description	Register Address		Data Type	Access	Data Range or Enumerated Selection
	Hex	Decimal			
Auxiliary Output *	0086	134	INT	R/W	0 = None 1 = Input 1 2 = Input 2 3 = PV 4 = Deviation 5 = Output 6 = Setpoint 7 = LSP 8 = RSP 9 = Input Algorithm 1
Low Scaling Factor	0031	049	FP	R/W	Within the range of the selected variable in ID 134
High Scaling Factor	0032	050	FP	R/W	Within the range of the selected variable in ID 134
Auxiliary Output Range	00EB	236	INT	R/W	0 = 4-20 mA 1 = 0-20 mA

Parameter Description	Register Address		Data Type	Access	Data Range or Enumerated Selection
	Hex	Decimal			
Digital Input #1	00BA	186	INT	R/W	0 = None 1 = To Manual 2 = To Local Setpoint #1 3 = To Local Setpoint #2 4 = To Local Setpoint #3 5 = To Direct Action 6 = To Hold Ramp 7 = To PID Set #2 8 = PV = Input 2 9 = Unused 10 = Rerun SPP Cycle 11 = To Run Ramp 12 = Reset SP Program 13 = Inhibit Reset 14 = To Manual/Failsafe Output 15 = Disable Keyboard 16 = To Automatic Output 17 = To Timer 18 = To Auto/Man Station 19 = Initiate Limit Cycle Tuning 20 = Setpoint Initialization (SP=PV) 21 = Output Tracks Input 2 22 = Unused 23 = Unused 24 = To RSP 25 = Unused 26 = External Reset Feedback 27 = To Purge 28 = To Low Fire 29 = Manual Latching 30 = Unused 31 = Unused 32 = PV Hold

Parameter Description	Register Address		Data Type	Access	Data Range or Enumerated Selection
	Hex	Decimal			
Digital Input #1 Combinations	00BC	188	INT	R/W	0 = Disable 1 = +PID2 2 = +Direct 3 = +LSP2 4 = +Disable Accutune 5 = +LSP1 6 = +Run
Digital Input #2 *	00BB	187	INT	R/W	Same as Digital Input #1
Digital Input #2 Combinations	00BC	189	INT	R/W	0 = Disable 1 = +PID2 2 = +Direct 3 = +LSP2 4 = +Disable Accutune 5 = +LSP1 6 = +Run
* Auxiliary Output and Digital Input #2 are mutually exclusive.					

10.7.10 Communications

Table 10-18 lists all the register addresses and ranges or selections for the function parameters in Set-up Group Communications.

Table 10-18 Set-up Group – Communications

Parameter Description	Register Address		Data Type	Access	Data Range or Enumerated Selection
	Hex	Decimal			
Shed Time	004F	79	INT	R/W	0 = No Shed 1 = 255 sample periods
Shed Mode and Output	00A2	162	INT	R/W	0 = Last Mode and Last Output 1 = Manual Mode, Last Output 2 = Manual Mode, Failsafe Output 3 = Automatic Mode
Shed Setpoint Recall	00A3	163	INT	R/W	0 = To Last Local Setpoint used 1 = CSP
Computer Setpoint Ratio	005A	90	FP	R/W	-20.00 to 20.00
Computer Setpoint Bias	005B	91	FP	R/W	-999 to 9999.
Communication Address	004D	77	FP	R/W	1 - 99
Communications Type	00E7	231	INT	R/W	0 = None 1 = Disable 2 = RS-485 Modbus 3 = Ethernet
IR Port Enable	00F1	241	INT	R/W	0 = Disable 1 = Enable
Baud Rate	00E8	232	INT	R/W	0 = 4800 1 = 9600 2 = 19200 3 = 38400
Transmit Delay	004E	78	FP	R/W	Response Delay in ms (1 to 500) +6ms
Floating Point Byte Order	00E9	233	INT	R/W	0 = Big Endian 1 = Big Endian Byte Swap 2 = Little Endian 3 = Little Endian Byte Swap
Shed Enable	00EA	234	INT	R/W	0 = Enable 1 = Disable
Shed Time	009A	154	INT	R/W	0 = No Shed 1 = 255 sample periods
Comm Data Units	00A1	161	INT	R/W	0 = Percent 1 = Engineering Units

10.7.11 Alarms

Table 10-19 lists all the register addresses and ranges or selections for the function parameters in Set-up Group Alarms.

Table 10-19 Set-up Group – Alarms

Parameter Description	Register Address		Data Type	Access	Data Range or Enumerated Selection
	Hex	Decimal			
Alarm 1 Setpoint 1 Value	0009	009	FP	R/W	Within the range of selected parameter or PV span for deviation alarm
Alarm 1 Setpoint 2 Value	000A	010	FP	R/W	Within the range of selected parameter or PV span for deviation alarm
Alarm 2 Setpoint 1 Value	000B	011	FP	R/W	Within the range of selected parameter or PV span for deviation alarm
Alarm 2 Setpoint 2 Value	000C	012	FP	R/W	Within the range of selected parameter or PV span for deviation alarm
Alarm 1 Setpoint 1 Type	008C	140	INT	R/W	0 = None 1 = Input 1 2 = Input 2 3 = PV 4 = Deviation 5 = Output 6 = Alarm on Shed 7 = SP Event On 8 = SP Event Off 9 = Manual 10 = Remote Setpoint 11 = Failsafe 12 = PV Rate of Change 13 = Alarm on Digital Input 1 14 = Alarm on Digital Input 2 15 = Loop Break 16 = T/C Warning 17 = T/C Fail 18 = PV Hot Start

Parameter Description	Register Address		Data Type	Access	Data Range or Enumerated Selection
	Hex	Decimal			
Alarm 1 Setpoint 2 Type	008E	142	INT	R/W	Same as 140
Alarm 2 Setpoint 1 Type	0090	144	INT	R/W	Same as 140
Alarm 2 Setpoint 2 Type	0092	146	INT	R/W	Same as 140
Alarm 1 Setpoint 1 Event	008D	141	INT	R/W	0 = Low Alarm 1 = High Alarm
Alarm 1 Setpoint 2 Event	008F	143	INT	R/W	0 = Low Alarm 1 = High Alarm
Alarm 2 Setpoint 1 Event	0091	145	INT	R/W	0 = Low Alarm 1 = High Alarm
Alarm 2 Setpoint 2 Event	0093	147	INT	R/W	0 = Low Alarm 1 = High Alarm
Alarm Hysteresis	0029	041	FP	R/W	0.0 to 100% of output or span
Alarm Latching for Output 1	00C8	200	INT	R/W	0 = Non Latching 1 = Latching
Alarm States	00C9	201	INT	R/W	State = 0 = Not in Alarm State = 1 = In Alarm Bit 0 = Alarm 11 State Bit 1 = Alarm 12 State Bit 2 = Alarm 21 State Bit 3 = Alarm 22 State Event = 0 = Low Event = 1 = High Bit 4 = Alarm 11 Event Bit 5 = Alarm 12 Event Bit 6 = Alarm 21 Event Bit 7 = Alarm 22 Event
Alarm 1 Blocking	00CA	202	INT	R/W	0 = Disable 1 = Block 1 2 = Block 2 3 = Block 1 2

Parameter Description	Register Address		Data Type	Access	Data Range or Enumerated Selection
	Hex	Decimal			
Diagnostic Alarm	009A	154	INT	R/W	0 = Disable 1 = Alarm 1 2 = Alarm 2

10.7.12 Display

Table 10-20 lists all the register addresses and ranges or selections for the function parameters in Set-up Group Display.

Table 10-20 Set-up Group – Display

Parameter Description	Register Address		Data Type	Access	Data Range or Enumerated Selection
	Hex	Decimal			
Decimal Point Location	009B	155	INT	R/W	0 = None – Fixed 1 = One – Floating decimal point to one 2 = Two – Floating decimal point to two 3 = Three – Floating decimal point to three
Temperature Units	0081	129	INT	R/W	0 = °F 1 = °C 2 = None
Power Frequency	00A6	166	INT	R/W	0 = 60 Hertz 1 = 50 Hertz
Language (Displays)	00C0	192	INT	R/W	0 = English 1 = French 2 = German 3 = Spanish 4 = Italian
Ratio Input 2 from Front Panel	00D0	208	INT	R/W	0 = Disable 1 = Enable

10.8 Modbus RTU Exception Codes

Introduction

When a master device sends a query to a slave device it expects a normal response. One of four possible events can occur from the master's query:

- *Slave device receives the query without a communication error and can handle the query normally.*
It returns a normal response.
- *Slave does not receive the query due to a communication error.*
No response is returned. The master program will eventually process a time-out condition for the query.
- *Slave receives the query but detects a communication error (parity, LRC or CRC).*
No response is returned. The master program will eventually process a time-out condition for the query.
- *Slave receives the query without a communication error but cannot handle it (i.e., request is to a non-existent coil or register).*
The slave will return with an exception response informing the master of the nature of the error (Illegal Data Address.)

The exception response message has two fields that differentiate it from a normal response:

Function Code Field:

In a normal response, the slave echoes the function code of the original query in the function code field of the response. All function codes have a most-significant bit (MSB) of 0 (their values are below 80 hex). In an exception response, the slave sets the MSB of the function code to 1. This makes the function code value in an exception response exactly 80 hex higher than the value would be for a normal response.

With the function code's MSB set, the master's application program can recognize the exception response and can examine the data field for the exception code.

Data Field:

In a normal response, the slave may return data or statistics in the data field. In an exception response, the slave returns an exception code in the data field. This defines the slave condition that caused the exception.

Query

Example: Internal slave error reading 2 registers starting at address 1820h from slave at slave address 02.
02 03 18 20 00 02 CRC CRC

Response

Example: Return MSB in Function Code byte set with Slave Device Failure (04) in the data field.
02 83 04 CRC CRC

Table 10-21 Modbus RTU Data Layer Status Exception Codes

Exception Code	Definition	Description
01	Illegal Function	The message received is not an allowable action for the addressed device.
02	Illegal Data Address	The address referenced in the function-dependent data section of the message is not valid in the addressed device.
03	Illegal Data Value	The value referenced at the addressed device location is no within range.
04	Slave Device Failure	The addressed device has not been able to process a valid message due to a bad device state.
06	Slave Device Busy	The addressed device has ejected a message due to a busy state. Retry later.
07	NAK, Negative Acknowledge	The addressed device cannot process the current message. Issue a PROGRAM POLL to obtain device-dependent error data.
09	Buffer Overflow	The data to be returned for the requested number of registers is greater than the available buffer space. <i>Function Code 20 only.</i>

11 Ethernet TCP/IP

11.1 Overview

Ethernet parameters can only be configured via the Process Instrument Explorer software.

Ethernet IP Address is 10.0.0.2 as shipped from the Factory.

The MAC address is printed on the case label of each instrument.

When constructing a network, it is recommended that a Switch be used to connect UDCs to a LAN rather than using a Hub. This is because a Switch passes only those messages for IP addresses that are connected to the Switch while a Hub passes all message traffic. Using a Switch thus improves the overall throughput of the traffic to and from the UDCs.

12 Further information

12.1 Modbus RTU Serial Communications

Refer to Honeywell document 51-52-25-66 Modbus RTU Serial Communications User Manual.

12.2 Modbus Messaging on TCP/IP

Refer to Honeywell document 51-52-25-121 MODBUS Messaging on TCP/IP Implementation Guide.

12.3 How to Apply Digital Instrumentation in Severe Electrical Noise Environments

Refer to Honeywell document 51-52-05-01 How to Apply Digital Instrumentation in Severe Electrical Noise Environments.

13 Index

A	
Aborting Accutune	115
Accutune Error Codes	115
Accutune III.....	4, 109
Accutune Set Up Group	48
Alarm Blocking	91
Alarm Hysteresis	90
Alarm Outputs	13
Alarm Relay Output Failure	165
Alarm Relays	17
Alarm Setpoints	118
Alarm Setpoints Display.....	119
Alarms	3
Alarms Set Up Group	87
Algorithm Set Up Group	50
Analog Input Signal Failure Operation	12
Analog Inputs	2, 12
Annunciators	100
Application Related Problems	154
Approval Body Options	4
Auto Bias	73
Auto/Manual Key	99
Automatic With Local Setpoint.....	105
Automatic With Remote Setpoint.....	105
Autotune Is Complete.....	116
Auxiliary Output	78
Auxiliary Output	3
Auxiliary Output Calibration.....	146
Auxiliary Output Connections.....	34
Auxiliary Output Failure	169
Auxiliary Output Range	79
B	
Background Tests	157
Baud Rate	84
Bias.....	65, 69
Burnout Protection	66, 69
C	
Calibration Mode.....	142, 151
Calibration Steps	133
Carbon Potential	57
Carbon Potential Selections.....	55
CE Conformity (Europe).....	8
CE Mark	4
Changing Control Modes	106
Changing The Local Setpoints	107
Communications.....	3
Communications Failure	167
Communications Group	84
Communications Selection	84
Composite Wiring Diagram.....	24
Computer Setpoint.....	190
Configuration.....	36
Configuration Data	185
Configuration Parameters	192
Configuration Procedure	39
Configuration Prompt Hierarchy	37
Configuration Record Sheet	94
Control Algorithm	50
Control And Alarm Relay Contact Information	17
Control Mode Definitions.....	105
Control Modes	105
Control Relays	17
Control Set Up Group.....	71
Control/Alarm Circuit Wiring	20
Controller Dropoff Value	75
Controller Failure Symptoms	159
Controller Grounding	20
Controller Output Types.....	13
Current Duplex	61
Current Output.....	31
Current Output.....	63
Current Output 2.....	78
Current Output Failure Symptoms.....	161
Current Outputs	13
Current Proportional Output Calibration.....	144
Current Simplex.....	60
Current/Time Duplex.....	61
Current/Time Or Time/Current Proportional Output Failure.....	164
Customer Support.....	155
Cycle Number.....	188
Cycle Time (Cool).....	42
Cycle Time (Heat)	42
Cycles Remaining.....	188
D	
Data Security	4
Data Transfer	185
Deadband.....	75
Decimal Point Location	92
Declaration Of Conformity.....	9
Demand Tuning.....	48
Dewpoint	55
Diagnostic.....	91
Diagnostic Alarm.....	91
Diagnostic Messages	102
Diagnostic/Failsafe Outputs	4
Digital Input (Remote) Operation.....	131
Digital Input Combinations	83

Digital Input Selections80
 Digital Inputs2, 12
 Digital Inputs Option Connections34
 Digital Output Status62
 Dimensions18
 Direct Acting Control74
 Display Indicators6
 Dual Electromechanical Relay Option Output .31

E

Elapsed Time108
 Electrical Considerations20
 Electrical Noise Precautions20
 Electromechanical Relay Output28
 Electromechanical Relays13
 Emc Classification9
 Emissivity67, 70
 Enclosure Rating9
 End Segment Number126
 Environmental And Operating Conditions14
 Equipment You Will Need To Calibrate135
 Error Codes115
 Error Messages102
 Estimated Motor Position120
 Ethernet7
 Ethernet Communications Failure168
 Ethernet Tcp/Ip221
 Ethernet Tcp/Ip Communications Interface14
 Ethernet Tcp/Ip Protocol84
 External Interface Option Connections33, 34
 External Setpoint Program Reset81
 External Wiring21

F

Factory Calibration141, 151
 Failsafe Function Prompt121, 122
 Failsafe Manual Mode156
 Failsafe Mode76
 Failsafe Mode122
 Failsafe Output Value76
 Failsafe Output Value121
 Failsafe Output Value For Restart After A Power
 Loss121
 Failure Modes4
 Fast Tune4
 Feedforward Multiplier54
 Feedforward Summer53
 Field Wiring135
 Filter66, 69
 Function Code 20178
 Function Code 21182
 Function Codes 20 And 21176
 Function Prompts37
 Fuzzy Logic5
 Fuzzy Overshoot Suppression48, 116

G

Gain40
 Gain 241
 Guaranteed Soak127

H

Heat/Cool (Duplex Tune)5
 High Scaling Factor56
 High Select54
 Hot Start46, 126
 Hydrogen Content57
 Hysteresis (Output Relay)75

I,J

Infrared7
 Infrared Communications8,14
 Input 1 Actuation Type64
 Input 1 And Input 2 Wiring Terminals135
 Input 1 Calibration Procedure140
 Input 1 Connections26
 Input 1 High Range Value65
 Input 1 Low Range Value65
 Input 1 Set Up Group64
 Input 1 Set Up Wiring136
 Input 2 Actuation Type68
 Input 2 Connections27
 Input 2 Set Up Group68
 Input Calibration132
 Installation11
 Installation Category9
 Installation Related Problems154
 IR Communications Port84
 Isolation13

K

Key Error99
 Key Lockout43, 99
 Keyboard Failure166
 Keys And Functions6

L

Latching122
 Line Voltage Wiring20
 Local Setpoint Source72
 Lockout42
 Lockout Feature98
 Lockout Levels98
 Loop Break88
 Low Fire83
 Low Scaling Factor56
 Low Select54
 Lower Display Key Parameter Prompts101

M

Mains Power Supply	20, 25
Manual.....	105
Manual Latching.....	83
Manual Reset.....	41
Mass Flow Orifice Constant (K) For Math Selections	56
Math Algorithms	53
Math Functions.....	2
Minimum And Maximum Range Values	133
Modbus.....	84
Modbus Read, Write And Override Parameters	185
Modbus RTU Exception Codes.....	219
Modbus RTU Function Codes.....	176
Model Number Interpretation.....	15
Moisture Protection	4
Motor Position Display	120
Motor Time.....	148
Motor Time.....	62
Mounting	18
Mounting Method.....	19
Mounting Procedure	19
Multiplier.....	54
Multiplier Divider.....	54
Multiplier Divider With Square Root.....	54
Multiplier With Square Root.....	54

N

Noise Immunity	4
Non-Latching	122

O

On/Off Algorithm.....	50
Open Collector Output	30
Open Collector Outputs.....	13
Operating Parameters	101
Operator Interface	5, 58, 97
Option Status	187
Output Algorithm	60
Output Calibration.....	143
Output Change Rate	74
Output Rate Down Value	75
Output Rate Up Value	75
Output Types	3
Overriding Controller Setpoint.....	190
Oxygen	55

P,Q

Parts Identification	174
Parts List.....	173
PD With Manual Reset.....	51
Permissible Wiring Bundling	21
Physical Considerations	18
PID A	51
PID B.....	51

Pollution Degree.....	9
Position Proportional Connections	32
Position Proportional Output Failure.....	162
Position Proportional Simplex.....	60
Power Consumption	14
Power Failure Symptoms.....	161
Power Inrush Current	14
Power Line Frequency.....	92
Power Outage	124, 131
Power-Up Tests	156
Pre-Installation Information	12
Process Instrument Explorer.....	7
Program Contents	125
Program Record Sheet.....	129
Program State	126
Program Termination State.....	126
Proportional Band.....	40
Proportional Band 2.....	41
Proportional Band Units	76
Purge.....	82
PV Hot Start	122

R

Ramp Time Or Rate Segments	127
Ramp/Soak Profile Example	128
Rate.....	40
Rate 2.....	41
Rate Down Value	45
Rate Up Value	45
Ratio	65, 69
Read Onlys	188
Reading Control Data	186
Recycle Number	126
Register Address Structure	177
Register Count.....	177
Remote Setpoint Source	73
Removing The Chassis	175
Rerun Current Segment	126
Reset	41
Reset 2	41
Reset Program To Beginning	126
Reset Units.....	77
Restore Factory Calibration.....	141, 151
Restoring Factory Configuration.....	170
Reverse Acting Control	74
RS 485	7
RS422/485 Modbus Rtu Communications Interface.....	14
RTD Inputs.....	137
Run/Hold Key.....	99
Run/Hold Key.....	123
Run/Monitor The Program	130

S

Security.....	4
Security Code	42
Security Code	97
Segment Time Remaining In Hours	188
Set Point Select Function Key	99
Set Up Group.....	37
Set Up Wiring Procedure For Auxiliary Output	146
Setpoint Code Selections	189
Setpoint High Limit.....	74
Setpoint Low Limit	74
Setpoint Ramp	44
Setpoint Ramp	123
Setpoint Ramp Final Setpoint.....	45
Setpoint Ramp Time.....	44
Setpoint Ramp/Soak Programming	4, 125
Setpoint Rate	45
Setpoint Rate	4, 123
Setpoint Tracking	73
Setpoints	4, 106, 189
Shed Time	85
Slowtune.....	5
Soak Segments	127
Software Type	188
Software Upgrade Part Number	172
Software Upgrades	171
Software Version.....	188
Software Version Number.....	155
Solid State Relay Output	29
Solid State Relays.....	13
SP Ramp Set Up Group.....	44
SP Tuning.....	48
Specifications	12
Start Segment Number	126
Start Up Procedure For Operation.....	104
Status Tests.....	156
Stray Rejection	12
Summer With Ratio And Bias	54
Suppression Devices	21
Switch Between Two Sets Via Keyboard	118
Switching Between Setpoints.....	107

T

Temperature Units.....	92
Test Failures	156
Thermocouple Health.....	2
Thermocouple Inputs Using A Thermocouple Source.....	137
Thermocouple Inputs Using An Ice Bath.....	136
Three Position Control Step Output Start-Up Mode.....	74
Three Position Step	52
Three Position Step Control	148
Three Position Step Control Algorithm.....	120

Three Position Step Control Connections	32
Three Position Step Test Failures	156
Time Current Duplex.....	61
Time Duplex.....	61
Time Proportional Output.....	60
Time Proportional Output Failure	163
Time Remaining	108
Time Simplex	60
Time-Out	109
Timer	4, 108
Timer	52
Transmitter Characterization	65, 69
Transmitter Power	3
Transmitter Power For 4-20 Ma	34, 35
Troubleshooting Aids	154
Troubleshooting Procedures.....	160
Troubleshooting/Service.....	153
Tune.....	110
Tune For Duplex (Heat/Cool)	111
Tuning	40
Tuning Constants.....	4
Tuning Indicators	109
Tuning Parameter Sets.....	71
Tuning Set Up Group	40
Two Sets Of Tuning Constants.....	116
TX Delay	85

U

Universal Output Functionality And Restrictions	22, 23
Universal Switching Power	4

V

Voltage And Resistance Equivalents For 0% And 100% Range Values.....	133
--	-----

W,X,Y,Z

Weight	14
Weighted Average Ratio	56
Wiring.....	20
Wiring Bundling.....	21
Wiring Connections For Calibrating Auxiliary Output.....	146
Wiring Connections For Calibrating Current Proportional Output.....	144
Wiring Connections For Radiamatic, Milliampere, Millivolts, Or Volts (Except 0 To 10 Volts)	138, 139
Wiring Connections For Rtd (Resistance Thermometer Device).....	137
Wiring Diagrams	22
Wiring The Controller	24
Worksheet.....	125
WS Float.....	85

14 Sales and Service

Sales and Service

For application assistance, current specifications, pricing, or name of the nearest Authorized Distributor, contact one of the offices below.

ASIA PACIFIC

(TAC)

dfs-tac-support@honeywell.com

Australia

Honeywell Limited
Phone: +(61) 7-3846 1255
FAX: +(61) 7-3840 6481
Toll Free 1300-36-39-36
Toll Free Fax:
1300-36-04-70

China – PRC - Shanghai

Honeywell China Inc.
Phone: (86-21) 5257-4568
Fax: (86-21) 6237-2826

Singapore

Honeywell Pte Ltd.
Phone: +(65) 6580 3278
Fax: +(65) 6445-3033

South Korea

Honeywell Korea Co Ltd
Phone: +(822) 799 6114
Fax: +(822) 792 9015

EMEA

Honeywell Process Solutions,
Phone: + 80012026455 or +44
(0)1202645583
FAX: +44 (0) 1344 655554

Email: (Sales)

sc-cp-apps-salespa62@honeywell.com

or

(TAC)
dfs-tac-support@honeywell.com

NORTH AMERICA

Honeywell Process Solutions,
Phone: 1-800-423-9883
Or 1-800-343-0228

Email: (Sales)

ask-ssc@honeywell.com

or

(TAC)
dfs-tac-support@honeywell.com

SOUTH AMERICA

Honeywell do Brasil & Cia
Phone: +(55-11) 7266-1900
FAX: +(55-11) 7266-1905

Email: (Sales)

ask-ssc@honeywell.com

or

(TAC)
dfs-tac-support@honeywell.com



Honeywell

AUTHORIZED DISTRIBUTOR

De Gidts & Feldman BV
The Netherlands
w w w . d g f g . n l



De Gidts & Feldman

INSTRUMENTATION & FILTRATION

Honeywell

Honeywell Process Solutions

1860 West Rose Garden Lane
Phoenix, Arizona 85027

www.honeywellprocess.com

51-52-25-119 Revision 5

March 2012

©2012 Honeywell International Inc.